

2019 ESC Guidelines for the management of patients with supraventricular tachycardia

The Task Force for the management of patients with supraventricular tachycardia of the European Society of Cardiology (ESC)

Developed in collaboration with the Association for European Paediatric and Congenital Cardiology (AEPC)

Authors/Task Force Members: Josep Brugada* (Chairperson) (Spain), Demosthenes G. Katritsis* (Chairperson) (Greece), Elena Arbelo (Spain), Fernando Arribas (Spain), Jeroen J. Bax (Netherlands), Carina Blomström-Lundqvist (Sweden), Hugh Calkins (United States of America), Domenico Corrado (Italy), Spyridon G. Deftereos (Greece), Gerhard-Paul Diller (Germany), Juan J. Gomez-Doblas (Spain), Bulent Gorenek (Turkey), Andrew Grace (United Kingdom), Siew Yen Ho (United Kingdom), Juan-Carlos Kaski (United Kingdom), Karl-Heinz Kuck (Germany), Pier David Lambiase (United Kingdom), Frederic Sacher (France), Georgia Sarquella-Brugada¹ (Spain), Piotr Suwalski (Poland), and Antonio Zaza (Italy)

* Corresponding authors: Josep Brugada, Cardiology Department, Hospital Clinic, and Pediatric Arrhythmia Unit, Hospital Sant Joan de Déu, University of Barcelona, Spain. Tel: +34 3460 902 2351, Fax: +34 3493 227 1777, Email: jbrugada@clinic.cat.

Demosthenes G. Katritsis, Department of Cardiology, Hygeia Hospital, E. Stavrou 4, 15123 Athens, Greece, Tel: +30 6944 845 505, Fax: +30 210 6722535, Email: dkatritsis@dgkatritsis.gr.

Author/Task Force Member Affiliations: listed in the Appendix.

ESC CPG and National Cardiac Societies document reviewers: listed in the Appendix.

¹Representing the AEPC.

ESC entities having participated in the development of this document:

Associations: Acute Cardiovascular Care Association (ACCA), European Association of Cardiovascular Imaging (EACVI), European Association of Preventive Cardiology (EAPC), European Heart Rhythm Association (EHRA), Heart Failure Association (HFA).

Councils: Council for Cardiology Practice.

Working Groups: Cardiac Cellular Electrophysiology, Cardiovascular Pharmacotherapy, Cardiovascular Surgery, Development Anatomy and Pathology, Grown-up Congenital Heart Disease.

The content of these ESC Guidelines has been published for personal and educational use only. No commercial use is authorized. No part of the ESC Guidelines may be translated or reproduced in any form without written permission from the ESC. Permission can be obtained upon submission of a written request to Oxford University Press, the publisher of the *European Heart Journal* and the party authorized to handle such permissions on behalf of the ESC (journals.permissions@oxfordjournals.org).

Disclaimer: The ESC Guidelines represent the views of the ESC and were produced after careful consideration of the scientific and medical knowledge, and the evidence available at the time of their publication. The ESC is not responsible in the event of any contradiction, discrepancy, and/or ambiguity between the ESC Guidelines and any other official recommendations or guidelines issued by the relevant public health authorities, in particular in relation to good use of healthcare or therapeutic strategies. Health professionals are encouraged to take the ESC Guidelines fully into account when exercising their clinical judgment, as well as in the determination and the implementation of preventive, diagnostic, or therapeutic medical strategies; however, the ESC Guidelines do not override, in any way whatsoever, the individual responsibility of health professionals to make appropriate and accurate decisions in consideration of each patient's health condition and in consultation with that patient and, where appropriate and/or necessary, the patient's caregiver. Nor do the ESC Guidelines exempt health professionals from taking into full and careful consideration the relevant official updated recommendations or guidelines issued by the competent public health authorities, in order to manage each patient's case in light of the scientifically accepted data pursuant to their respective ethical and professional obligations. It is also the health professional's responsibility to verify the applicable rules and regulations relating to drugs and medical devices at the time of prescription.

Document Reviewers: Tom De Potter [Committee for Practice Guidelines (CPG) Review Coordinator] (Belgium), Christian Sticherling (CPG Review Coordinator) (Switzerland), Victor Aboyans (France), Cristina Basso (Italy), Mario Bocchiardo (Italy), Werner Budts (Belgium), Victoria Delgado (Netherlands), Dobromir Dobrev (Germany), Donna Fitzsimons (United Kingdom), Sofie Gevaert (Belgium), Hein Heidbuchel (Belgium), Gerhard Hindricks (Germany), Peter Hlavak (Slovakia), Prapa Kanagaratnam (United Kingdom), Hugo Katus (Germany), Josef Kautzner (Czech Republic), Thomas Kriebel¹ (Germany), Patrizio Lancellotti (Belgium), Ulf Landmesser (Germany), Christophe Leclercq (France), Basil Lewis (Israel), Yury Lopatin (Russian Federation), Béla Merkely (Hungary), Thomas Paul (Germany), Nikola Pavlović (Croatia), Steffen Petersen (United Kingdom), Anna Sonia Petronio (Italy), Tatjana Potpara (Serbia), Marco Roffi (Switzerland), Daniel Scherr (Austria), Evgeny Shlyakhto (Russian Federation), Iain A. Simpson (United Kingdom), Katja Zeppenfeld (Netherlands)

The disclosure forms of all experts involved in the development of these Guidelines are available on the ESC website www.escardio.org/guidelines

SD For the Supplementary Data which include background information and detailed discussion of the data that have provided the basis for the Guidelines see <https://academic.oup.com/eurheartj/article-lookup/doi/10.1093/eurheartj/ehz467#supplementary-data>

Click here to access the corresponding chapter in ESC CardioMed - Section 40 Supraventricular tachycardias

Online publish-ahead-of-print 31 August 2019

Keywords

Guidelines • arrhythmia • tachycardia • supraventricular • flutter • atrioventricular • re-entrant • focal • macro-re-entrant • junctional • nodal • pre-excitation • ablation

Table of contents

1 Preamble	659	9.2.1.3 QRS axis	668
2 Introduction	661	9.2.1.4 Chest lead concordance	668
2.1 Evidence review	661	9.2.1.5 Right bundle branch block morphology	669
2.2 Relationships with industry and other conflicts of interest	661	9.2.1.6 Left bundle branch block morphology	669
2.3 What is new in the 2019 Guidelines?	661	9.2.2 Electrophysiology study	670
2.3.1 Change in recommendations from 2003 to 2019	661	9.3 Irregular tachycardias	670
2.3.2 New recommendations in 2019	662	10 Acute management in the absence of an established diagnosis ...	670
2.3.3 New revised concepts	662	10.1 Regular tachycardias	670
3 Definitions and classification	662	10.1.1 Narrow QRS (≤ 120 ms) tachycardias	670
4 Electrophysiological mechanisms of supraventricular tachycardia	663	10.1.1.1 Haemodynamically unstable patients	670
5 Cardiac anatomy for the electrophysiologist	664	10.1.1.2 Haemodynamically stable patients	670
6 Epidemiology of supraventricular tachycardia	664	10.1.2 Wide QRS (120 ms) tachycardias	672
7 Clinical presentation	664	10.1.2.1 Haemodynamically unstable patients	672
8 Initial evaluation of patients with supraventricular tachycardia	665	10.1.2.2 Haemodynamically stable patients	672
9 Differential diagnosis of tachycardias	665	10.2 Irregular tachycardias	673
9.1 Narrow QRS (≤ 120 ms) tachycardias	665	11 Specific types of supraventricular tachycardia	673
9.1.1 Electrocardiographic differential diagnosis	665	11.1 Atrial arrhythmias	673
9.1.1.1 Initiation and termination of the tachycardia	665	11.1.1 Sinus tachycardia	673
9.1.1.2 Regularity of tachycardia cycle length	665	11.1.1.1 Physiological sinus tachycardia	673
9.1.1.3 P/QRS relationship	665	11.1.1.2 Inappropriate sinus tachycardia	673
9.1.2 Vagal manoeuvres and adenosine	667	11.1.1.2.1 Diagnosis	673
9.1.3 Electrophysiology study	668	11.1.1.2.2 Therapy	673
9.2 Wide QRS (> 120 ms) tachycardias	668	11.1.1.3 Sinus node re-entrant tachycardia	674
9.2.1 Electrocardiographic differential diagnosis	668	11.1.1.3.1 Diagnosis	674
9.2.1.1 Atrioventricular dissociation	668	11.1.1.3.2 Therapy	674
9.2.1.2 QRS duration	668	11.1.1.4 Postural orthostatic tachycardia syndrome	674
		11.1.1.4.1 Diagnosis	674
		11.1.1.4.2 Therapy	675
		11.1.2 Focal atrial tachycardia	675

11.1.2.1 Diagnosis	675	12.2 Catheter and surgical ablation	696
11.1.2.2 Acute therapy	675	12.3 Specific disease states	696
11.1.2.3 Catheter ablation	675	12.3.1 Atrial septal defect	696
11.1.2.4 Chronic therapy	677	12.3.2 Ebstein's anomaly	696
11.1.3 Multifocal atrial tachycardia	678	12.3.3 Transposition of the great arteries (dextro-transposition of the great arteries) after atrial switch operation (Mustard or Senning)	696
11.1.3.1 Therapy	678	12.3.4 Tetralogy of Fallot	697
11.1.4 Macro-re-entrant atrial tachycardias	678	12.3.5 Fontan repairs	697
11.1.4.1 Cavotricuspid isthmus-dependent macro-re-entrant atrial tachycardia	678	13 Supraventricular tachycardia in the paediatric population	697
11.1.4.1.1 Typical atrial flutter: common (counter-clockwise) and reverse (clockwise)	678	13.1 Foetal arrhythmias	697
11.1.4.1.2 Diagnosis	678	14 Supraventricular tachycardia in pregnancy	697
11.1.4.1.3 Acute therapy	679	14.1 Maternal, obstetric, and offspring risk	698
11.1.4.1.4 Catheter ablation	681	14.2 Therapy	698
11.1.4.1.5 Chronic therapy	681	14.2.1 Antiarrhythmic drugs	698
11.1.4.1.6 Anticoagulation	681	14.2.2 Electrical cardioversion	699
11.1.4.1.7 Other cavotricuspid isthmus-dependent macro-re-entrant atrial tachycardia	681	14.2.3 Catheter ablation	699
11.1.4.2 Non-cavotricuspid isthmus-dependent macro-re-entrant atrial tachycardia	681	15 Tachycardia-induced cardiomyopathy	699
11.1.4.2.1 Right atrium macro-re-entrant atrial tachycardia	681	15.1 Definition	699
11.1.4.2.2 Left atrium macro-re-entrant atrial tachycardia	682	15.2 Mechanism	699
11.2 Atrioventricular junctional arrhythmias	683	15.3 Diagnosis	699
11.2.1 Atrioventricular nodal re-entrant tachycardia	683	15.4 Therapy	699
11.2.1.1 Diagnosis	683	16 Supraventricular tachycardia in sports	700
11.2.1.1.1 12 lead electrocardiogram during tachycardia	683	17 Supraventricular tachycardia and driving restrictions	700
11.2.1.1.2 Electrophysiology study	684	18 Key messages	701
11.2.1.1.3 Typical atrioventricular nodal re-entrant tachycardia	684	19 Gaps in the evidence	701
11.2.1.1.4 Atypical atrioventricular nodal re-entrant tachycardia	684	20 Evidence-based 'what to do' and 'what not to do' messages from the Guidelines	702
11.2.1.2 Therapy	684	21 Areas for further research	705
11.2.1.2.1 Acute therapy	685	22 Supplementary data	705
11.2.1.2.2 Catheter ablation	685	23 Appendix	705
11.2.1.2.3 Chronic therapy	685	24 References	706
11.2.2 Non-re-entrant junctional tachycardias	686	Recommendations	
11.3 Atrioventricular arrhythmias	686	Recommendations for the acute management of narrow QRS tachycardia in the absence of an established diagnosis	670
11.3.1 Accessory pathways	686	Recommendations for the acute management of wide QRS tachycardia in the absence of an established diagnosis	672
11.3.2 Wolff–Parkinson–White syndrome	687	Recommendations for the therapy of sinus tachycardias	674
11.3.3 Orthodromic atrioventricular re-entrant tachycardia	687	Recommendations for the therapy of focal atrial tachycardia	676
11.3.4 Antidromic atrioventricular re-entrant tachycardia	688	Recommendations for the therapy of multifocal atrial tachycardia	678
11.3.5 Accessory pathway as a bystander	688	Recommendations for the therapy of macro-re-entrant atrial arrhythmias	679
11.3.6 Pre-excited atrial fibrillation	688	Recommendations for the management of atrioventricular nodal re-entrant tachycardia	684
11.3.7 Concealed accessory pathways	688	Recommendations for the therapy of atrioventricular re-entrant tachycardia due to manifest or concealed accessory pathways	690
11.3.8 Permanent junctional reciprocating tachycardia	689	Recommendations for the acute therapy of pre-excited atrial fibrillation	691
11.3.9 Atypical forms of pre-excitation	689	Recommendations for the management of patients with asymptomatic pre-excitation	693
11.3.10 Therapy	690	Recommendations for the therapy of supraventricular tachycardias in congenital heart disease in adults	696
11.3.10.1 Acute therapy	690	Recommendations for the therapy of supraventricular tachycardia in pregnancy	698
11.3.10.2 Catheter ablation	692		
11.3.10.3 Chronic therapy	692		
11.3.11 The asymptomatic patient with pre-excitation	692		
12 Supraventricular tachycardia in adults with congenital heart disease	695		
12.1 Pharmacological antiarrhythmic therapy	695		

Recommendations for the therapy of supraventricular tachycardia in patients with suspected or established heart failure due to tachycardiomyopathy	699
Recommendations for the acute management of narrow QRS tachycardia in the absence of an established diagnosis	702

List of tables

Table 1 Classes of recommendations	660
Table 2 Levels of evidence	660
Table 3 Changes in drug recommendations since 2003	661
Table 4 New recommendations in 2019	662
Table 5 Conventional classification of supraventricular tachycardia	663
Table 6 Differential diagnosis of narrow and wide QRS tachycardias	663
Table 7 Initial evaluation of the patient with supraventricular tachycardia	664
Table 8 Possible responses of narrow QRS tachycardia to vagal manoeuvres and adenosine	667
Table 9 Summary of key electrocardiographic criteria that suggest ventricular tachycardia rather than supraventricular tachycardia in wide complex tachycardia	668
Table 10 Causes of physiological sinus tachycardia	673
Table 11 Average success and complications rates of catheter ablation for supraventricular tachycardia	677
Table 12 Classification of atrioventricular nodal re-entrant tachycardia types	684
Table 13 Recommendations for sports participation in athletes with ventricular pre-excitation and supraventricular arrhythmias ...	700
Table 14 European Working Group 2013 report on driving and cardiovascular disease: driving in arrhythmias and conduction disorders: supraventricular tachycardia	701

List of figures

Figure 1 Differential diagnosis of narrow QRS tachycardia.	666
Figure 2 Responses of narrow complex tachycardias to adenosine.	667
Figure 3 Examples of positive and negative chest lead concordance.	669
Figure 4 Acute therapy of narrow QRS tachycardia in the absence of an established diagnosis.	671
Figure 5 Acute therapy of wide complex tachycardia in the absence of an established diagnosis	672
Figure 6 Therapy of sinus tachycardias	674
Figure 7 Focal atrial tachycardia	676
Figure 8 Acute therapy of focal atrial tachycardia	677
Figure 9 Chronic therapy of focal atrial tachycardia	677
Figure 10 Counter-clockwise and clockwise atrial flutter with 2:1 atrioventricular conduction	678
Figure 11 Acute therapy of stable atrial flutter or macro-re-entrant atrial tachycardia.	680
Figure 12 Chronic therapy of atrial flutter/macro-re-entrant atrial tachycardia	682
Figure 13 Atrioventricular nodal re-entrant tachycardia	683
Figure 14 Acute therapy of atrioventricular nodal re-entrant tachycardia.	685

Figure 15 Chronic therapy of atrioventricular nodal re-entrant tachycardia.	686
Figure 16 The St George's algorithm for localization of accessory pathways	687
Figure 17 Localization of accessory pathways in the presence of maximum (spontaneous or evoked) pre-excitation	688
Figure 18 Atrioventricular re-entrant tachycardia	689
Figure 19 Acute therapy of atrioventricular re-entrant tachycardia.	691
Figure 20 Acute therapy of pre-excited atrial fibrillation.	692
Figure 21 Chronic therapy of atrioventricular re-entrant tachycardia.	692
Figure 22 Risk stratification and therapy of patients with asymptomatic pre-excitation.	694

Abbreviations and acronyms

+/-	QRS complex equiphase
+ve	QRS complex-positive
-ve	QRS complex-negative
ACHD	Adult congenital heart disease
AEPC	Association for European Paediatric and Congenital Cardiology
AF	Atrial fibrillation
AH	Atrial-His
AMP	Adenosine monophosphate
AP	Accessory pathway
AT	Atrial tachycardia
AV	Atrioventricular
AVN	Atrioventricular node
AVNRT	Atrioventricular nodal re-entrant tachycardia
AVRT	Atrioventricular re-entrant tachycardia
BBB	Bundle branch block
b.p.m.	Beats per minute
CHA2DS2-	Cardiac failure, Hypertension, Age ≥ 75 (Doubled),
VASC	Diabetes, Stroke (Doubled) – Vascular disease, Age 65–74 and Sex category (Female)
CL	Cycle length
CMR	Cardiac magnetic resonance
CT	Computed tomography
CTI	Cavotricuspid isthmus
CV	Conduction velocity
CYP	Cytochrome P450
DAD	Delayed after-depolarization
DC	Direct current
DCS	Distal coronary sinus
EA	Enhanced automaticity
EAD	Early after-depolarization
ECG	Electrocardiogram/electrocardiographic
EPS	Electrophysiology study
ERP	Effective refractory period
ESC	European Society of Cardiology
HA	His-atrial interval
HCN	Hyperpolarization-activated cyclic nucleotide-gated potassium channel
HF	Heart failure

HFrEF	Heart failure with reduced ejection fraction
HPS	His–Purkinje system
HV	His–ventricular interval
ICaL	L-type Ca ²⁺ current
ICD	Implantable cardioverter defibrillator
IST	Inappropriate sinus tachycardia
i.v.	Intravenous
JET	Junctional ectopic tachycardia
LA	Left atrial/atrium
LAL	Left anterolateral
LBBB	Left bundle branch block
LL	Left lateral
LP	Left posterior
LPL	Left posterolateral
LPS	Left posteroseptal
LV	Left ventricle/ventricular
MI	Myocardial infarction
MRAT	Macro-re-entrant atrial tachycardia
MS	Mid-septal
NT-proBNP	N-terminal pro-B-type natriuretic peptide
PJRT	Permanent junctional reciprocating tachycardia
p.o.	Per os (by mouth)
POTS	Postural orthostatic tachycardia syndrome
PPM	Permanent pacemaker
PRKAG2	Protein kinase AMP-activated non-catalytic subunit gamma 2
PV	Pulmonary vein
RA	Right atrial/anterior
RAS	Right anteroseptal
RBBB	Right bundle branch block
RCT	Randomized clinical trial
RL	Right lateral
RP	Right posterior
RPS	Right posteroseptal
RyR	Sarcoplasmic reticulum Ca ²⁺ channel
SPERRI	Shortest pre-excited RR interval during atrial fibrillation
SR	Sarcoplasmic reticulum
SVT	Supraventricular tachycardia
TA	Triggered activity
TCM	Tachycardiomyopathy
TDI	Tissue Doppler imaging
VA	Ventriculoatrial
VT	Ventricular tachycardia
WL	Wavelength
WPW	Wolff-Parkinson-White

1 Preamble

Guidelines summarize and evaluate available evidence with the aim of assisting health professionals in proposing the best management strategies for an individual patient with a given condition. Guidelines and their recommendations should facilitate decision making of health professionals in their daily practice. However, the final decisions concerning an individual patient must be made by the

responsible health professional(s) in consultation with the patient and caregiver as appropriate.

A great number of guidelines have been issued in recent years by the European Society of Cardiology (ESC), as well as by other societies and organisations. Because of their impact on clinical practice, quality criteria for the development of guidelines have been established in order to make all decisions transparent to the user. The recommendations for formulating and issuing ESC Guidelines can be found on the ESC website (<http://www.escardio.org/Guidelines-&Education/Clinical-Practice-Guidelines/Guidelines-development/Writing-ESC-Guidelines>). The ESC Guidelines represent the official position of the ESC on a given topic and are regularly updated.

The ESC carries out a number of registries which are essential to assess, diagnostic/therapeutic processes, use of resources and adherence to Guidelines. These registries aim at providing a better understanding of medical practice in Europe and around the world, based on data collected during routine clinical practice.

The guidelines are developed together with derivative educational material addressing the cultural and professional needs for cardiologists and allied professionals. Collecting high-quality observational data, at appropriate time interval following the release of ESC Guidelines, will help evaluate the level of implementation of the Guidelines, checking in priority the key end points defined with the ESC Guidelines and Education Committees and Task Force members in charge.

The Members of this Task Force were selected by the ESC, including representation from its relevant ESC sub-specialty groups, in order to represent professionals involved with the medical care of patients with this pathology. Selected experts in the field undertook a comprehensive review of the published evidence for management of a given condition according to ESC Committee for Practice Guidelines (CPG) policy. A critical evaluation of diagnostic and therapeutic procedures was performed, including assessment of the risk–benefit ratio. The level of evidence and the strength of the recommendation of particular management options were weighed and graded according to predefined ESC scales, as outlined in *tables 1* and *2* below.

The experts of the writing and reviewing panels provided declaration of interest forms for all relationships that might be perceived as real or potential sources of conflicts of interest. These forms were compiled into one file and can be found on the ESC website (<http://www.escardio.org/guidelines>). Any changes in declarations of interest that arise during the writing period were notified to the ESC and updated. The Task Force received its entire financial support from the ESC without any involvement from the healthcare industry.

The ESC CPG supervises and coordinates the preparation of new Guidelines. The Committee is also responsible for the endorsement process of these Guidelines. The ESC Guidelines undergo extensive review by the CPG and external experts. After appropriate revisions the Guidelines are approved by all the experts involved in the Task Force. The finalized document is approved by the CPG for publication in the *European Heart Journal*. The Guidelines were developed after careful consideration of the scientific and medical knowledge and the evidence available at the time of their dating.

The task of developing ESC Guidelines also includes the creation of educational tools and implementation programmes for the recommendations including condensed pocket guideline versions, summary

Table 1 Classes of recommendations

	Definition	Wording to use	
Classes of recommendations	Class I	Evidence and/or general agreement that a given treatment or procedure is beneficial, useful, effective.	Is recommended or is indicated
	Class II	Conflicting evidence and/or a divergence of opinion about the usefulness/efficacy of the given treatment or procedure.	
	Class IIa	Weight of evidence/opinion is in favour of usefulness/efficacy.	Should be considered
	Class IIb	Usefulness/efficacy is less well established by evidence/opinion.	May be considered
	Class III	Evidence or general agreement that the given treatment or procedure is not useful/effective, and in some cases may be harmful.	Is not recommended

© ESC 2019

Table 2 Classes of recommendations

Level of evidence A	Data derived from multiple randomized clinical trials or meta-analyses.
Level of evidence B	Data derived from a single randomized clinical trial or large non-randomized studies.
Level of evidence C	Consensus of opinion of the experts and/or small studies, retrospective studies, registries.

© ESC 2019

slides, booklets with essential messages, summary cards for non-specialists and an electronic version for digital applications (smartphones, etc.). These versions are abridged and thus, for more detailed information, the user should always access to the full text version of the Guidelines, which is freely available via the ESC website and hosted on the EHJ website. The National Societies of the ESC are encouraged to endorse, translate and implement all ESC Guidelines. Implementation programmes are needed because it has been shown that the outcome of disease may be

favourably influenced by the thorough application of clinical recommendations.

Health professionals are encouraged to take the ESC Guidelines fully into account when exercising their clinical judgment, as well as in the determination and the implementation of preventive, diagnostic or therapeutic medical strategies. However, the ESC Guidelines do not override in any way whatsoever the individual responsibility of health professionals to make appropriate and accurate decisions in consideration of each patient’s health condition and in consultation

with that patient or the patient's caregiver where appropriate and/or necessary. It is also the health professional's responsibility to verify the rules and regulations applicable in each country to drugs and devices at the time of prescription.

2 Introduction

Supraventricular arrhythmias are common and patients are often symptomatic, requiring management with drugs and electrophysiological procedures. The ESC published management Guidelines for supraventricular tachycardias (SVTs) in 2003¹; corresponding US guidelines have also been published, the most recent being in 2015.²

There is a need to provide expert recommendations for professionals participating in the care of patients presenting with SVT. In addition, several associated conditions where SVTs may coexist need to be explained in more detail. To address this topic, a Task Force was convened by the ESC, with the remit to comprehensively review the published evidence and to publish Guidelines on the management of patients with SVT, with up-to-date consensus recommendations for clinical practice. This document summarizes current developments in the field, with a focus on advances since the last ESC Guidelines were published, and provides general recommendations for the management of adults with SVT based on the principles of evidence-based medicine.

2.1 Evidence review

Members of the Task Force were asked to perform a detailed literature review, weigh the strength of evidence for or against a particular treatment or procedure, and include estimates of expected health outcomes where data exist. Patient-specific modifiers, comorbidities, and issues of patient preference that might influence the choice of particular tests or therapies were considered, as were frequency of follow-up and cost-effectiveness. In controversial areas, or with regard to issues without evidence other than usual clinical practice, consensus was achieved by agreement of the expert panel after thorough deliberation. The document was peer-reviewed by official external reviewers.

The strengths of the recommendations and levels of evidence of particular management options were weighed and graded according to predefined scales, as outlined above in Tables 1 and 2, respectively.

Overall, these Guidelines include evidence and expert opinions from several countries. The pharmacological and non-pharmacological antiarrhythmic approaches discussed may therefore include drugs that do not have the approval of governmental regulatory agencies in all countries.

2.2 Relationships with industry and other conflicts of interest

It is ESC policy to sponsor position papers and Guidelines without commercial support, and all members volunteered their time. Thus, all members of the writing group, as well as the reviewers, have disclosed any potential conflicts of interest in detail. The details of these declarations will be posted on the ESC website upon publication of these Guidelines.

2.3 What is new in the 2019 Guidelines?

2.3.1 Change in recommendations from 2003 to 2019

Owing to the fact that the previous Guidelines on SVT were published 16 years ago, many drugs that were recommended at that time are not considered in the 2019 Guidelines. In addition, techniques and indications of ablation techniques have changed. These recommendation changes are indicated for each section in Table 3 below.

Table 3 Changes in SVT Guidelines recommendations since 2003

	2003	2019
Acute management of narrow QRS tachycardias		
Verapamil and diltiazem	I	IIa
Beta-blockers	IIb	IIa
<i>Amiodarone and digoxin are not mentioned in the 2019 Guidelines</i>		
Acute management of wide QRS tachycardias		
Procainamide	I	IIa
Adenosine	IIb	IIa
Amiodarone	I	IIb
<i>Sotalol and lidocaine are not mentioned in the 2019 Guidelines</i>		
Therapy of inappropriate sinus tachycardia		
Beta-blockers	I	IIa
<i>Verapamil/diltiazem and catheter ablation are not mentioned in the 2019 Guidelines</i>		
Therapy of postural orthostatic tachycardia syndrome		
Salt and fluid intake	IIa	IIb
<i>Head-up tilt sleep, compression stockings, selective beta-blockers, fludrocortisone, clonidine, methylphenidate, fluoxetine, erythropoietin, ergotamine/octreotide, and phenobarbitone are not mentioned in the 2019 guidelines.</i>		
Therapy of focal AT		
Acute		
Flecainide/propafenone	IIa	IIb
Amiodarone	IIa	IIb
<i>Procainamide, sotalol, and digoxin are not mentioned in the 2019 Guidelines</i>		
Chronic		
Beta-blockers	I	IIa
Verapamil and diltiazem	I	IIa
<i>Sotalol and disopyramide are not mentioned in the 2019 Guidelines</i>		
Therapy of atrial flutter		
Acute		
Atrial or transoesophageal pacing	I	IIb
Ibutilide	IIa	I
Flecainide/propafenone	IIb	III

Continued

Table 3 Continued

	2003	2019
Verapamil and diltiazem	I	IIa
Beta-blockers	I	IIa
<i>Digitalis is not mentioned in the 2019 Guidelines</i>		
Chronic		
<i>Dofetilide, sotalol, flecainide, propafenone, procainamide, quinidine, and disopyramide are not mentioned in the 2019 Guidelines</i>		
Therapy of AVNRT		
Acute		
<i>Amiodarone, sotalol, flecainide, and propafenone are not mentioned in the 2019 Guidelines</i>		
Chronic		
Verapamil and diltiazem	I	IIa
Beta-blockers	I	IIa
<i>Amiodarone, sotalol, flecainide, propafenone, and the ‘pill-in-the pocket’ approach are not mentioned in the 2019 Guidelines</i>		
Therapy of AVRT		
Flecainide/propafenone	IIa	IIb
Beta-blockers	IIb	IIa
<i>Amiodarone, sotalol, and the ‘pill-in-the pocket’ approach are not mentioned in the 2019 Guidelines</i>		
SVT in pregnancy		
Verapamil	IIb	IIa
Catheter ablation	IIb	IIa*
<i>Sotalol, propranolol, quinidine, and procainamide are not mentioned in the 2019 Guidelines.</i>		

© ESC 2019

*: when fluoroless ablation is available. AT = atrial tachycardia; AVNRT = atrioventricular nodal re-entrant tachycardia; AVRT = atrioventricular re-entrant tachycardia.

2.3.2 New recommendations in 2019

Table 4 New recommendations in 2019

Ivabradine alone or in combination with a beta-blocker should be considered in symptomatic patients with inappropriate sinus tachycardia.	IIa
Ibutilide (i.v.) ibutilide may be considered for acute therapy of focal atrial tachycardia.	IIb
Ivabradine for postural orthostatic tachycardia syndrome, and ivabradine with a beta-blocker for chronic therapy of focal atrial tachycardia, may be considered.	IIb
Patients with atrial flutter without AF should be considered for anticoagulation, but the threshold for initiation is not established.	IIa
Ibutilide (i.v.), or i.v. or oral (in-hospital) dofetilide are recommended for conversion of atrial flutter.	I
High-rate atrial pacing is recommended for termination of atrial flutter in the presence of an implanted pacemaker or defibrillator.	I

Continued

i.v. amiodarone is not recommended for pre-excited AF.	III
Performance of an EPS to risk-stratify individuals with asymptomatic pre-excitation should be considered.	IIa
Catheter ablation is recommended in asymptomatic patients in whom electrophysiology testing with the use of isoprenaline identifies high-risk properties, such as SPERRI ≤250 ms, AP ERP ≤250 ms, multiple APs, and an inducible AP-mediated tachycardia.	I
Non-invasive evaluation of the conducting properties of the AP in individuals with asymptomatic pre-excitation may be considered.	IIb
Catheter ablation may be considered in a patient with asymptomatic pre-excitation and low-risk AP at invasive or non-invasive risk stratification.	IIb
Catheter ablations should be considered in patients with asymptomatic pre-excitation and LV dysfunction due to electrical dyssynchrony.	IIa
AV nodal ablation with subsequent pacing (‘ablate and pace’), either biventricular or His-bundle pacing, is recommended if a tachycardia responsible for TCM cannot be ablated or controlled by drugs.	I
During the first trimester of pregnancy, it is recommended that all antiarrhythmic drugs are avoided, if possible.	I
In pregnant women, beta-1 selective blockers (except atenolol) or verapamil, in order of preference, should be considered for prevention of SVT in patients without WPW syndrome.	IIa
In pregnant women, flecainide or propafenone should be considered for prevention of SVT in patients with WPW syndrome and without ischaemic or structural heart disease.	IIa

AF = atrial fibrillation; AP = accessory pathway; AT = atrial tachycardia; AV = atrioventricular; EPS = electrophysiology study; ERP = effective refractory period; i.v. = intravenous; LV = left ventricular; POTS: postural orthostatic tachycardia syndrome; SPERRI = shortest pre-excited RR interval during atrial fibrillation; SVT = supraventricular tachycardia; TCM = tachycardiomyopathy; WPW = Wolff-Parkinson-White.

© ESC 2019

2.3.3 New revised concepts

- Drug therapy for inappropriate sinus tachycardia and focal atrial tachycardia.
- Therapeutic options for acute conversion and anticoagulation of atrial flutter.
- Therapy of atrioventricular nodal re-entrant tachycardia.
- Therapy of antidromic atrioventricular re-entrant tachycardia and pre-excited atrial fibrillation.
- Management of patients with asymptomatic pre-excitation.
- Diagnosis and therapy of tachycardiomyopathy.

3 Definitions and classification

The term ‘SVT’ literally indicates tachycardia [atrial rates >100 beats per minute (b.p.m.) at rest], the mechanism of which involves tissue from the His bundle or above.^{2,3} Traditionally, SVT has been used to describe all kinds of tachycardias apart from ventricular tachycardias (VTs) and AF. It has therefore included tachycardias such as atrioventricular (AV) re-entry due to accessory connections, which is not, in

Table 5 Conventional classification of supraventricular tachycardias

Atrial tachycardias
Sinus tachycardia
<ul style="list-style-type: none"> • Physiological sinus tachycardia • Inappropriate sinus tachycardia • Sinus nodal re-entrant tachycardia
Focal AT
Multifocal AT
MRAT
<ul style="list-style-type: none"> • Cavotricuspid isthmus-dependent MRAT <ul style="list-style-type: none"> – Typical atrial flutter, counter-clockwise (common) or clockwise (reverse) – Other cavotricuspid isthmus-dependent MRAT • Non-cavotricuspid isthmus-dependent MRAT <ul style="list-style-type: none"> – RA MRAT – LA MRAT
AF
AV junctional tachycardias
Atrioventricular nodal re-entrant tachycardia (AVNRT)
<ul style="list-style-type: none"> • Typical • Atypical
Non-re-entrant junctional tachycardia
<ul style="list-style-type: none"> • JET (junctional ectopic or focal junctional tachycardia) • Other non-re-entrant variants
Atrioventricular re-entrant tachycardia (AVRT)
<ul style="list-style-type: none"> • Orthodromic (including PJRT) • Antidromic (with retrograde conduction through the AVN or, rarely, over another pathway)

AF = atrial fibrillation; AT = atrial tachycardia; AV = atrioventricular; AVN = atrioventricular node; JET = junctional ectopic tachycardia; RA = right atrial; LA = left atrial; MRAT = macro-re-entrant atrial tachycardia; PJRT = permanent junctional reciprocating tachycardia; RA = right atrial.

essence, a supraventricular rhythm (Table 5). The term 'narrow QRS tachycardia' indicates those with a QRS duration ≤ 120 ms. A wide QRS tachycardia refers to one with a QRS duration > 120 ms (Table 6). In clinical practice, SVT may present as narrow or wide QRS tachycardias, most of which, although not invariably, manifest as regular rhythms. These Guidelines do not cover AF, which is the subject of separate clinical Guidelines⁴ and various consensus documents.^{5–7}

4 Electrophysiological mechanisms of supraventricular tachycardia

Arrhythmia can originate from abnormal impulse initiation in an individual myocyte or, more realistically, in a close cluster of myocytes. This can occur in non-pacemaker cells through a mechanism similar to the physiological automaticity of pacemaker cells [sinus node and AV node (AVN)], and is thus named 'abnormal' or 'enhanced automaticity'. An alternative form of abnormal impulse initiation involves oscillations of

Table 6 Differential diagnosis of narrow and wide QRS tachycardias

Narrow QRS (≤ 120 ms) tachycardias
Regular
<ul style="list-style-type: none"> • Physiological sinus tachycardia • Inappropriate sinus tachycardia • Sinus nodal re-entrant tachycardia • Focal AT • Atrial flutter with fixed AV conduction • AVNRT • JET (or other non-re-entrant variants) • Orthodromic AVRT • Idiopathic VT (especially high septal VT)
Irregular
<ul style="list-style-type: none"> • AF • Focal AT or atrial flutter with varying AV block • Multifocal AT
Wide QRS (> 120 ms) tachycardias
Regular
<ul style="list-style-type: none"> • VT/flutter • Ventricular paced rhythm • Antidromic AVRT • SVTs with aberration/BBB (pre-existing or rate-dependent during tachycardia) • Atrial or junctional tachycardia with pre-excitation/bystander AP • SVT with QRS widening due to electrolyte disturbance or antiarrhythmic drugs
Irregular
<ul style="list-style-type: none"> • AF or atrial flutter or focal AT with varying block conducted with aberration • Antidromic AV re-entrant tachycardia due to a nodo-ventricular/fascicular AP with variable VA conduction • Pre-excited AF • Polymorphic VT • Torsade de pointes • Ventricular fibrillation
Occasionally, AF with very fast ventricular response may apparently resemble a regular narrow QRS tachycardia.

AF = atrial fibrillation; AP = accessory pathway; AT = atrial tachycardia; AV = atrioventricular; AVNRT = atrioventricular nodal re-entrant tachycardia; AVRT = atrioventricular re-entrant tachycardia; BBB = bundle branch block; JET = junctional ectopic tachycardia; SVT = supraventricular tachycardia; VA = ventriculoatrial; VT = ventricular tachycardia.

membrane potential, named early or delayed 'after-depolarizations'. In such cases, the resulting arrhythmias take the name of 'triggered activity'.⁸ Arrhythmias resulting from enhanced automaticity and triggered activity are defined as 'non-re-entrant'. Arrhythmias can also arise when myocardial regions activated later in propagation re-excite regions that have already recovered excitability. This results from abnormal propagation of the excitation wavefront and/or of tissue refractoriness. This mechanism, named 're-entry', is based on the syncytial nature of myocardial tissue and is thus radically different from focal impulse initiation.⁸ A detailed discussion and schematic representation of common SVT circuits is provided in the Supplementary Data.

5 Cardiac anatomy for the electrophysiologist

Knowledge of anatomical structures inside and outside the atrial chambers is of clinical importance, especially when interventional procedures are being considered. A detailed discussion is provided in the Supplementary Data.

6 Epidemiology of supraventricular tachycardia

Epidemiological studies on the SVT population are limited. In the general population, the SVT prevalence is 2.25/1000 persons and the incidence is 35/100 000 person-years. Women have a risk of developing SVT that is two times greater than that of men, and persons aged ≥ 65 years or have more than five times the risk of developing SVT than younger individuals. Patients with lone paroxysmal SVT vs. those with cardiovascular disease are younger, have a faster SVT rate, have an earlier onset of symptoms, and are more likely to have their condition first documented in the emergency department.⁹ In a paediatric cohort study of 1967911 live births between 2000–08, 2021 patients (51.6% male, overall incidence 1.03/1000) had SVT [Wolff-Parkinson-White (WPW) syndrome accounted for 16.2%]. By the age of 15 years, the annual risk of sudden death was 0.01% per patient-year.¹⁰

In specialized centres, AVNRT is the most frequently treated substrate after AF, followed by atrial flutter and AVRT, in patients referred for catheter ablation.^{11–13} Women are more likely to be affected by AVNRT than men (ratio $\sim 70:30$),^{14–16} while the converse is true for AVRT (ratio 45:55).¹⁴ A relationship with the monthly cycle has been suggested,¹⁷ and episodes are more frequent during pregnancy in women with pre-existing SVT.¹⁸

In the general population, the prevalence of a WPW pattern on surface electrocardiogram (ECG) ranges from 0.15–0.25%,¹⁹ increasing to 0.55% among first-degree relatives of affected patients.²⁰ However, not all patients develop SVT and intermittent pre-excitation is not rare. Compared with the remaining population, the pre-excitation population is generally younger, predominantly male, and has less comorbidity.^{21,22} The proportion of patients with AVRT decreases with age, whereas the proportion of those with AVNRT and AT increases with age.¹⁴

The epidemiology of atrial flutter is not known with certainty, as atrial flutter and AF can coexist. The prevalence of AF before flutter ablation ranges from 24–62%, and after ablation could be 30–70%. The overall incidence of atrial flutter is 88/100 000 person-years in the US population annually. Adjusted for age, the incidence of atrial flutter in men (125/100 000) is >2.5 times that of women (59/100 000) and increases exponentially with age. Patients with atrial flutter are more likely to have been smokers, have a longer PR interval, history of myocardial infarction (MI), and history of heart failure (HF).²³

Catheter ablation is now used extensively for most varieties of SVT, and patient-reported outcome measures have shown that patients experience significant improvements in their quality of life following ablation.^{24–27} Patient-reported outcome measures using

various questionnaires are useful in the audit of ablation techniques. Women are more often prescribed antiarrhythmic drugs before ablation for SVT than men,²⁸ and recurrence rates following AVNRT ablation are higher in young women.²⁹ However, overall, no significant differences in health-related quality of life or access to healthcare resources between men and women have been reported.²⁸

7 Clinical presentation

The impact of SVT on an individual is based on a range of factors and may result in palpitations, fatigue, light-headedness, chest discomfort, dyspnoea, and altered consciousness.³⁰ Rapid rhythms are more likely to present with a clear history and acutely than less-rapid rhythms, but SVT usually produces symptoms.³¹ The duration of symptoms and the patient's age at onset are important. An individual with an onset in the teenage years or younger is less likely to have AT or AF continuing into adulthood. Such a long history will point towards a re-entrant mechanism.³² Dyspnoea, or other clinical signs and symptoms of HF, can occur when the patient has developed TCM. Light-headedness in association with SVT is not infrequent.³⁰ Presyncope and syncope are less common,^{33,34} and tend to be associated with presentation in older individuals.³² In older patients, symptoms may be more extreme—with dizziness, presyncope, and syncope—in view of the less-accommodating characteristics of the circulation; drops in blood pressure are usually immediate and tend to recover.³⁵ In some patients, a description of polyuria (possibly due to atrial stretch-induced atrial natriuretic peptide activity) can be elucidated, although this is infrequent.³⁶ Direct risks due to SVT are unusual, but in specific situations (e.g. in patients with WPW syndrome and AF,²² or after atrial switch operation³⁷) may lead to sudden cardiac death.

A sudden onset more likely points to AVNRT or AVRT, although an AT may also present in this way.³² Characteristics in terms of the regularity or irregularity are helpful. The duration of individual episodes may help in terms of differentiation. Re-entrant tachycardias

Table 7 Initial evaluation of the patient with supraventricular tachycardia

Standard
<ul style="list-style-type: none"> History, physical examination, and 12 lead ECG Full blood counts, biochemistry profile, and thyroid function An ECG during tachycardia should be sought Transthoracic echocardiography
Optional
<ul style="list-style-type: none"> Exercise tolerance testing 24 h ECG monitoring, transtelephonic monitoring, or an implantable loop recorder Myocardial ischaemia testing in patients with risk factors for coronary artery disease (including men aged >40 years and post-menopausal women) An EPS should be considered for a definitive diagnosis and when catheter ablation is anticipated

ECG = electrocardiogram; EPS = electrophysiology study.

tend to last longer than AT episodes, which may occur in a series of repetitive runs.³² Clear descriptions of pounding in the neck (the so-called 'frog sign') or 'shirt flapping' would point to the possible competing influences of atrial and ventricular contraction on the tricuspid valve, and to AVNRT as a likely cause.^{15,38,39}

SVT may be unrecognized at initial medical evaluation and the clinical characteristics can mimic panic disorder.⁴⁰ In patients with possible sinus tachycardia in association with anxiety and postural orthostatic tachycardia syndrome (POTS), it is important to rule out the possibility of a re-entrant tachycardia.

8 Initial evaluation of patients with supraventricular tachycardia

Complete history taking, including family history, and physical examination are essential. As discussed, clinical history is especially relevant in cases of palpitations without ECG documentation of the tachycardia. Initial evaluation points to a re-entrant arrhythmia when the mode of onset/termination is sudden, is often associated with a change of position, and the tachycardia is perceived as regular. Initiation of the episode(s), frequency, and conditions of triggering the arrhythmia are important clues for a specific diagnosis.³ There may be evidence that specific actions lead to arrhythmia termination. These could include standard vagal manoeuvres,⁴¹ but also abortive measures such as drinking a glass of iced water. Also, responses to the administration of drugs (e.g. adenosine or verapamil), where termination has been observed but ECGs are missing, may provide diagnostic help.

Full blood counts and a biochemistry profile—including renal function, electrolytes, and thyroid function tests—can be useful in specific cases (Table 7). An ECG recorded during tachycardia is ideal, and patients should be encouraged to seek medical assistance and recording of their ECG during episodes. A 12 lead resting ECG and baseline echocardiographic assessment are necessary. It may be useful to do 24 h ECG recordings, but tachycardia episodes are usually sporadic and may not be frequent enough to be recorded on ambulatory monitoring. Transtelephonic monitoring, mobile recording devices, or, very rarely, an implantable loop recorder may be required. Wrist-worn, optically based heart rate monitors are user-friendly, but appropriate validation of the device used is imperative.⁴² A tolerance exercise test may also be useful in patients with apparent pre-excitation and in cases of catecholamine-dependent arrhythmias. Myocardial ischaemia testing is also needed in patients with angina or significant risk factors for coronary artery disease.⁴³ An electrophysiology study (EPS) is usually necessary to establish the diagnosis, particularly when catheter ablation is anticipated.

9 Differential diagnosis of tachycardias

9.1 Narrow QRS (≤ 120 ms) tachycardias

Narrow QRS complexes are due to rapid activation of the ventricles via the His–Purkinje system (HPS), which suggests that the origin of the arrhythmia is above or within the His bundle. However, early

activation of the His bundle can also occur in high septal VTs, thus resulting in relatively narrow QRS complexes (110–140 ms).⁴⁴

9.1.1 Electrocardiographic differential diagnosis

In the absence of an ECG recorded during the tachycardia, a 12 lead ECG in sinus rhythm may provide clues for the diagnosis of SVT and should be scrutinized for any abnormality. The presence of pre-excitation in a patient with a history of regular paroxysmal palpitations is generally suggestive of AVRT. The absence of apparent pre-excitation does not rule out the diagnosis of AVRT, as it may be due to a concealed accessory pathway (AP) that conducts only retrogradely or to an atypical (Mahaim) pathway, which is latent at sinus rhythm.

An ECG taken during tachycardia is very useful in the efficient diagnosis of SVT, although it may fail to lead to a specific diagnosis.⁴⁵ It may not be available in patients with very short or infrequent periods of palpitations.

9.1.1.1 Initiation and termination of the tachycardia

Sudden prolongation of the PR interval occurs in typical AVNRT after an atrial ectopic beat. An AT may also be initiated by an atrial ectopic beat, but is not dependent on marked PR prolongation. Automatic, focal ATs are characterized by gradual acceleration (warm-up phenomenon) followed by deceleration (cool-down phenomenon),⁴⁶ and may also be incessant with short interruption by sinus beats. Premature atrial or ventricular beats may trigger AVRT. Premature ventricular complexes are a common trigger of atypical AVNRT, but rarely induce typical AVNRT, and only exceptionally AT.

9.1.1.2 Regularity of tachycardia cycle length

The regularity of the RR interval should be assessed (Figure 1). Irregular tachycardias may represent focal or multifocal AT, focal AF, and atrial flutter with varying AV conduction. Patterns of irregularity can sometimes be found, such as in atrial flutter conducted with Wenckebach periodicity. Irregular arrhythmias, such as multifocal AT, typically display variable P-wave morphologies, and varying PP, RR, and PR intervals. Atrial flutter can have fixed AV conduction and present as a regular tachycardia, and even AF may appear almost regular when very fast. Re-entrant tachycardias, whether micro- or macro-re-entries, are usually regular. Incessant tachycardias may be the so-called permanent junctional reciprocating tachycardia (PJRT), focal AT, or, rarely, atypical AVNRT. Cycle length (CL) alternans (also called RR alternans) may be seen in AVNRT, but these changes are $<15\%$ of the tachycardia CL.⁴⁷ If the irregularity exceeds 15% of the CL, a focal arrhythmia is much more likely.⁴⁸ QRS alternans is a rare phenomenon in slow SVTs, which may not be related to CL alternans, and has been initially described with AVRT.^{49,50} However, this may be seen in any fast SVT.⁵¹

A change in ventricular CL preceded by a change in atrial CL is seen in AT or atypical AVNRT. A change in ventricular CL preceding a change in subsequent atrial CL favours typical AVNRT or AVRT.^{47,52} A fixed ventriculoatrial (VA) interval in the presence of variable RR intervals excludes AT.⁴⁵

9.1.1.3 P/QRS relationship

According to their P/QRS relationships, SVTs are classified as having short or long RP intervals. Short-RP SVTs are those with RP intervals

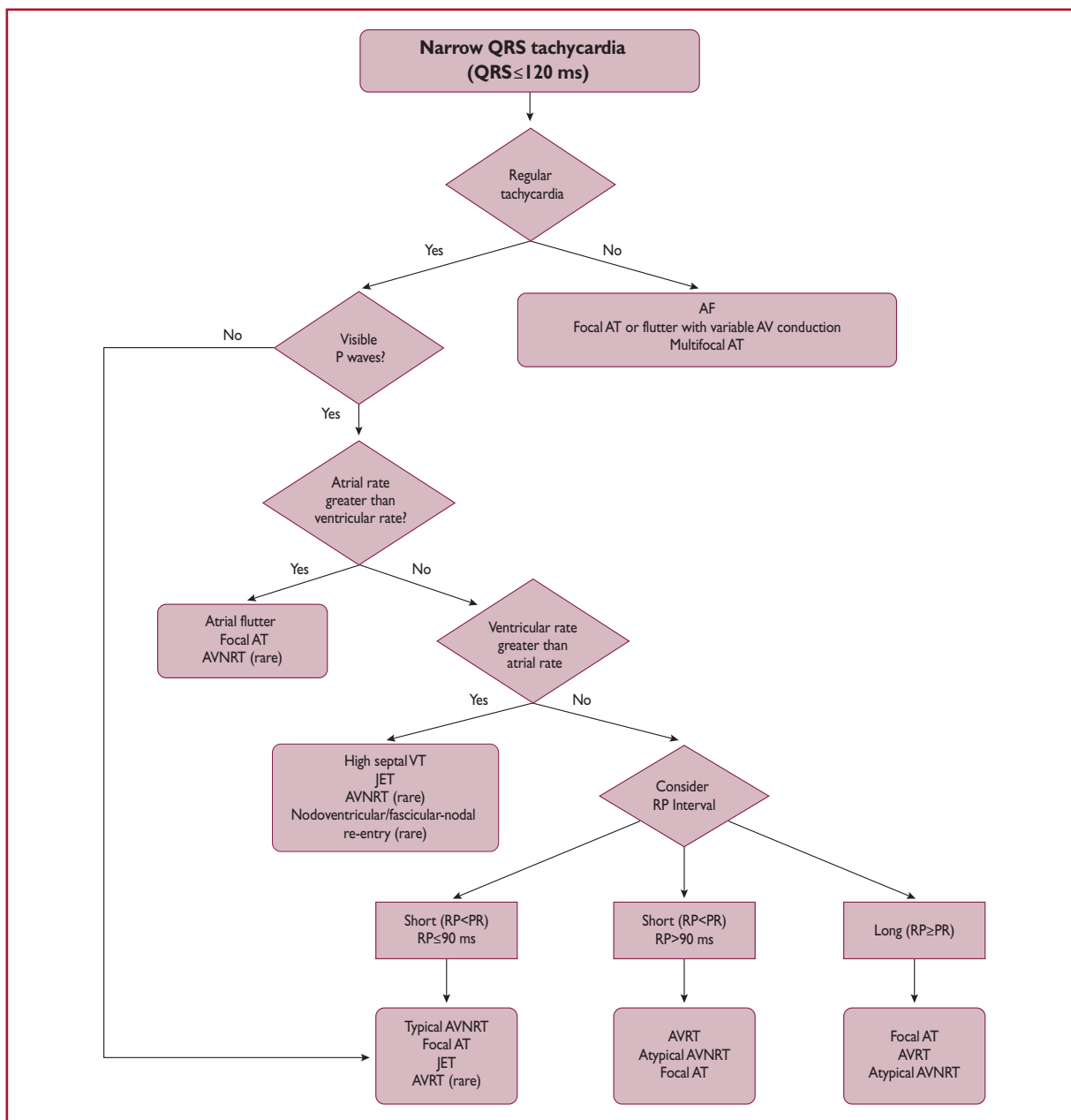

©ESC 2019

Figure 1 Differential diagnosis of narrow QRS tachycardia. Recording of a retrograde P wave should be sought by obtaining a 12 lead Electrocardiogram and, if necessary, using the Lewis leads or even an oesophageal lead connected to a pre-cordial lead (V1) with use of alligator clamps. The 90 ms cut-off is a rather arbitrary number used for surface electrocardiogram measurements if P waves are visible and is based on limited data. In the electrophysiology laboratory, the cut-off of the ventriculoatrial interval is 70 ms. Junctional ectopic tachycardia may also present with atrioventricular dissociation.

AF = atrial fibrillation; AT = atrial tachycardia; AV = atrioventricular; AVNRT = atrioventricular nodal re-entrant tachycardia; AVRT = atrioventricular re-entrant tachycardia; JET = junctional ectopic tachycardia; RP = RP interval; VT = ventricular tachycardia.

shorter than one-half the tachycardia RR interval, whereas long-RP SVTs display $RP \geq PR$ (Figure 1). Rarely, recording of U waves during typical AVNRT may simulate a long-RP tachycardia.⁵³

On EPS, a very short VA interval (≤ 70 ms) usually indicates typical AVNRT, or less commonly focal AT, but has also been reported in AVRT.⁵⁴ For surface ECG measurements, a cut-off interval of 90 ms has been shown to be useful and can be used if P waves are visible,⁵⁵ but data on actual RP measurements during various types of SVT are scarce.

P waves similar to those in normal sinus rhythm suggest appropriate or inappropriate sinus nodal tachycardia, sinus nodal re-entrant tachycardia, or focal AT arising close to the sinus node. P waves different from those in sinus rhythm, and conducted with a PR interval equal to or longer than the PR in sinus rhythm, are typically seen in focal AT. In AT, the conduction to the ventricles may be fast (1:1) or slow (3:1 or 4:1). The possibility of atrial flutter with 2:1 conduction should also be considered if the ventricular rate during SVT is ~ 150 b.p.m., as the atrial activity is usually 250–330 b.p.m. In the presence of antiarrhythmic medication in this setting, lowering the atrial rate may result in a higher ventricular rate in the absence of AV nodal blockade.

In the case of relatively delayed retrograde conduction that allows the identification of retrograde P waves, a pseudo r deflection in lead V1 and a pseudo S wave in the inferior leads are more common in typical AVNRT than in AVRT or AT.^{56,57} These criteria are specific (91–100%) but modestly sensitive (58 and 14%, respectively).⁵⁶ A difference in RP intervals in leads V1 and III > 20 ms is also indicative of AVNRT rather than AVRT due to a posteroseptal pathway.⁵⁷ The presence of a QRS notch in lead aVL has also been found to be a reliable criterion suggesting AVNRT,⁵⁸ while a pseudo r in aVR has been shown to have greater sensitivity and specificity than a pseudo r in V1 for the diagnosis of typical AVNRT.⁵⁹ However, in all referenced studies, cases of AT or atypical AVNRT were limited or entirely absent.

AV block or dissociation during narrow QRS tachycardia is not often seen, but it rules out AVRT as both atria and ventricles are parts of the circuit. The development of bundle branch block (BBB) during SVT may also be helpful in the diagnosis of AVRT. BBB ipsilateral to the AP can result in CL prolongation due to VA prolongation, as the ventricular arm of the circuit is prolonged by conduction through the interventricular septum from the conducting bundle branch.⁶⁰ However, it should be noted that lengthening of the VA interval may not necessarily result in CL prolongation, due to a potential switch of antegrade conduction from the slow to the fast AV nodal pathway.

9.1.2 Vagal manoeuvres and adenosine

Vagal manoeuvres (such as carotid sinus massage) and adenosine injection may help in clinical diagnosis, particularly in situations in which the ECG during tachycardia is unclear. Possible responses to vagal manoeuvres and adenosine are shown in Table 8 and Figure 2.

Termination of the arrhythmia with a P wave after the last QRS complex is very unlikely in AT, and most common in AVRT and typical AVNRT. Termination with a QRS complex is often seen in AT, and possibly in atypical AVNRT. Adenosine does not interrupt macro-re-entrant ATs (MRATs).⁶¹ Fascicular VTs, in particular, are

verapamil- but not adenosine-sensitive. Most VTs, as opposed to SVTs, do not respond to carotid sinus massage, but a narrow QRS VT originating at the left bundle branch and terminated with carotid sinus massage has been reported.⁶²

Table 8 Possible responses of narrow QRS tachycardia to vagal manoeuvres and adenosine

- (1) Slowing of AVN conduction and induction of intermittent AV block. Atrial electrical activity can thus be unmasked, revealing dissociated P waves (focal AT, atrial flutter, or AF waves).
- (2) Temporary decrease in the atrial rate of automatic tachycardias (focal AT, sinus tachycardia, and JET).
- (3) Tachycardia termination. This can happen by interrupting the re-entry circuit in AVNRT and AVRT by acting on the AVN that is part of the circuit. More rarely, sinus nodal re-entry and ATs due to triggered activity can slow down and terminate.
- (4) No effect is observed in some cases.

AF = atrial fibrillation; AT = atrial tachycardia; AV = atrioventricular; AVN = atrioventricular node; AVNRT = atrioventricular nodal re-entrant tachycardia; AVRT = atrioventricular re-entrant tachycardia; JET = junctional ectopic tachycardia.

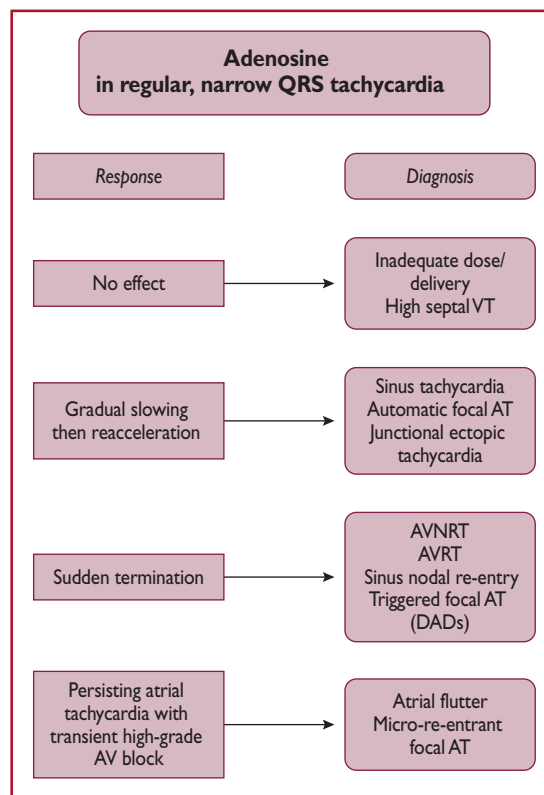

Figure 2 Responses of narrow-complex tachycardias to adenosine.

AT = atrial tachycardia; AV = atrioventricular; AVNRT = atrioventricular nodal re-entrant tachycardia; AVRT = atrioventricular re-entrant tachycardia; DADs = delayed after-depolarizations; VT = ventricular tachycardia.

9.1.3 Electrophysiology study

Several electrophysiological techniques and manoeuvres can be employed in the electrophysiology laboratory for differential diagnosis of regular narrow QRS tachycardia.⁴⁵ A detailed discussion is beyond the scope of these Guidelines.

9.2 Wide QRS (>120 ms) tachycardias

Wide QRS tachycardias can be VT, SVT conducting with BBB aberration, or antegrade conduction over an AP, with reported proportions of 80, 15, and 5%, respectively.⁶³ The correct diagnosis of a VT is critical to management, as misdiagnosis and administration of drugs usually utilized for SVT can be harmful for patients in VT.⁶⁴ **Therefore, the default diagnosis should be VT until proven otherwise.** The differential diagnosis includes:⁶⁵

- (1) SVT with BBB. This may arise due to pre-existing BBB or the development of aberrancy during tachycardia (so-called phase 3 block), which is more commonly, although not invariably, a right BBB (RBBB) pattern due to the longer RP of the right bundle branch.
- (2) SVT with antegrade conduction over an AP, 'pre-excited SVT', which participates in the circuit (antidromic AVRT) or is a bystander during AF, focal AT/atrial flutter, or AVNRT.
- (3) SVT with widening of QRS interval induced by drugs or electrolyte disturbances. Class IA and IC drugs cause use-dependent slowing of conduction, and class III drugs prolong refractoriness at His–Purkinje tissue more than in the ventricular myocardium. They can both result in atypical BBB morphologies during SVT that mimics VT.
- (4) Pacemaker-related endless loop tachycardia and artefacts, which can also mimic VT.

9.2.1 Electrocardiographic differential diagnosis

If the 12 lead ECG is available in sinus rhythm, it can provide useful diagnostic information. Specifically, if the QRS morphology is identical during sinus rhythm and tachycardia, the arrhythmia is most likely not a VT. However, bundle branch re-entrant VTs and high septal VTs exiting close to the conduction system can have similar morphologies to sinus rhythm. The presence of a contralateral BBB pattern in sinus rhythm is more indicative of VT.

9.2.1.1 Atrioventricular dissociation

The presence of either AV dissociation or capture/fusion beats in the 12 lead ECG during tachycardia are key diagnostic features of VT. AV dissociation may be difficult to recognize because P waves are often hidden by wide QRS and T waves during a wide QRS tachycardia. P waves are usually more prominent in inferior leads and in modified chest lead placement (Lewis lead).⁶³

The relationship between atrial and ventricular events is 1:1 or greater (more atrial than ventricular beats) in most SVTs (Table 9). AVNRT can be associated with 2:1 conduction,⁶⁶ but this is rare. Although VA conduction can be found in ≤50% of patients with VT and a 1:1 relationship is possible, most VTs have a relationship <1:1 (more QRS complexes than P waves).

Table 9 Summary of key electrocardiographic criteria that suggest ventricular tachycardia rather than supraventricular tachycardia in wide complex tachycardia

AV dissociation	Ventricular rate > atrial rate
Fusion/capture beats	Different QRS morphology from that of tachycardia
Chest lead negative concordance	All precordial chest leads negative
RS in precordial leads	- Absence of RS in precordial leads - RS >100 ms in any lead ^a
QRS complex in aVR	<ul style="list-style-type: none"> • Initial R wave • Initial R or Q wave >40 ms • Presence of a notch of a predominantly negative complex
QRS axis -90 to ±180°	Both in the presence of RBBB and LBBB morphology
R wave peak time in lead II	R wave peak time ≥50 ms
RBBB morphology	<p>Lead V1: Monophasic R, Rsr', biphasic qR complex, broad R (>40 ms), and a double-peaked R wave with the left peak taller than the right (the so-called 'rabbit ear' sign)</p> <p>Lead V6: R:S ratio <1 (rS, QS patterns)</p>
LBBB morphology	<p>Lead V1: Broad R wave, slurred or notched-down stroke of the S wave, and delayed nadir of S wave</p> <p>Lead V6: Q or QS wave</p>

AV = atrioventricular; LBBB = left bundle branch block; RBBB = right bundle branch block.

^aRS: beginning of R to deepest part of S.

9.2.1.2 QRS duration

A QRS duration >140 ms with RBBB or >160 ms with left BBB (LBBB) pattern suggests VT. These criteria are not helpful for differentiating VT from SVT in specific settings, such as pre-excited SVT, or when class IC or class IA antiarrhythmic drugs are administered.⁶⁷

9.2.1.3 QRS axis

As VT circuits (especially post-MI or in cardiomyopathies) frequently lie outside the normal His–Purkinje network, significant axis shifts are likely to occur, enabling diagnosis. Therefore, in patients with SVT and aberrancy, the QRS axis is confined between -60 and +120°. In particular, extreme axis deviation (axis from -90 to ±180°) is strongly indicative of VT, both in the presence of RBBB and LBBB.⁶⁵

9.2.1.4 Chest lead concordance

The presence of negative chest lead concordance (all QRS complexes negative V1–V6) (Figure 3) is almost diagnostic of VT, with a specificity >90%, but is only present in 20% of VTs. Positive concordance can be indicative of VT or an antidromic tachycardia utilizing a left posterior or left lateral AP.⁶⁸

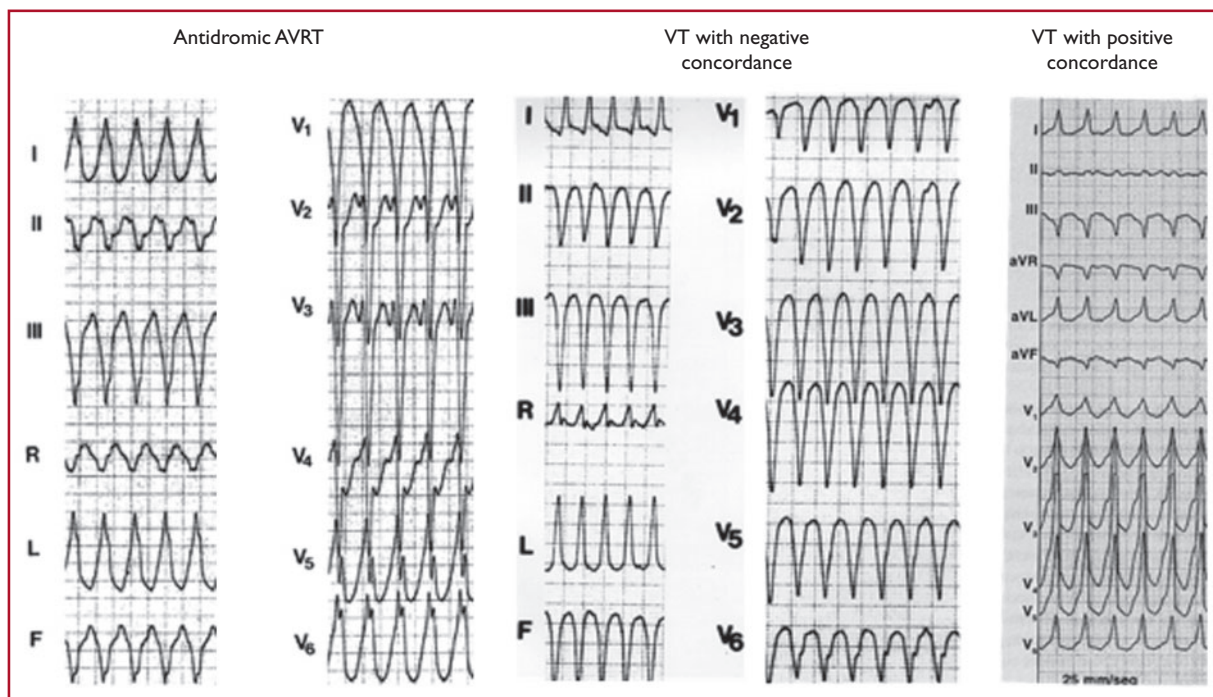

Figure 3 Examples of positive and negative chest lead concordance in VT. AVRT = atrioventricular re-entrant tachycardia; VT = ventricular tachycardia.

9.2.1.5 Right bundle branch block morphology

Lead V1: Typical RBBB aberrancy has a small initial r_s , because in RBBB the high septum is activated primarily from the left septal bundle. Therefore, the following patterns are evident: rSR_s , rSr_s , or rR_s in lead V1. However, in VT, the activation wavefront progresses from the left ventricle (LV) to the right precordial lead V1, in a way that a prominent R wave (monophasic R, Rsr_s , biphasic qR complex, or broad R >40 ms) will be more commonly seen in lead V1. Additionally, a double-peaked R wave (M pattern) in lead V1 favours VT if the left peak is taller than the right peak (the so-called 'rabbit ear' sign). A taller right rabbit ear characterizes the RBBB aberrancy but does not exclude VT.

Lead V6: A small amount of normal right ventricular voltage is directed away from lead V6. As this is a small vector in RBBB aberrancy, the R:S ratio is >1 . In VT, all of the right ventricular voltage, and some of the left, is directed away from V6, leading to an R:S ratio <1 (rS and QS patterns). An RBBB morphology with an R:S ratio in V6 of <1 is seen rarely in SVT with aberrancy, mainly when the patient has a left axis deviation during sinus rhythm.

Differentiating fascicular VT from SVT with bifascicular block (RBBB and left anterior hemiblock) is very challenging. Features that indicate SVT in this context include QRS >140 ms, overall negative QRS in aVR, and an R/S ratio >1 in V6.⁴⁴

9.2.1.6 Left bundle branch block morphology

Lead V1: As stated above for RBBB, for the same reasons, the presence of a broad R wave, slurred or notched-down stroke of

the S wave, and delayed nadir of the S wave are strong predictors of VT.

Lead V6: In true LBBB, no Q wave is present in the lateral precordial leads. Therefore, the presence of any Q or QS wave in lead V6 favours VT, indicating that the activation wavefront is moving away from the LV apical site.

These morphology criteria are not fulfilled in any lead in 4% of SVTs and 6% of VTs, and in one-third of cases when one lead (V1 or V6) favours one diagnosis, the other favours the opposite diagnosis (VT in one lead and SVT in the other, and vice versa).^{69,70}

A number of algorithms have been developed to differentiate VT from SVT.^{69,71,72} Detailed presentation and comments are beyond the scope of these Guidelines, and can be found in the 2018 European Heart Rhythm Association/Heart Rhythm Society/Asia Pacific Heart Rhythm Society/Sociedad Latinoamericana de Estimulación Cardíaca y Electrofisiología consensus document.³

All of these criteria have limitations. Conditions such as bundle branch re-entrant tachycardia, fascicular VT, VT with exit site close to the His–Purkinje system, and wide QRS tachycardia occurring during antiarrhythmic drug treatment are difficult to diagnose using the mentioned morphological criteria. Differentiating VT from antidromic AVRT is extremely difficult for the very fact that the QRS morphology in antidromic AVRT is similar to that of a VT, with its origin at the insertion of the AP in the ventricular myocardium. An algorithm has been derived for differential diagnosis, based on the analysis of 267 wide QRS tachycardias, consisting of VT and antidromic

AVRT. The derived criteria were found to offer sensitivity of 75% and specificity of 100%,⁷³ and the algorithm was also validated in another study,⁷⁴ but experience is still limited.

In fact, several independent studies have found that various ECG-based methods have specificities of 40–80% and accuracies of ~75%.^{44,68,75–80} Indeed, a similar diagnostic accuracy of ~75% would be achieved effortlessly by considering every wide QRS tachycardia to be a VT, because only 25–30% are SVTs. Therefore, emerging approaches to integrate these algorithms and provide more accurate scoring systems are being evaluated.⁸¹ Furthermore, conventional ECG criteria have reduced the sensitivity to distinguish VT from SVT with aberrancy in patients with idiopathic VT. This is most pronounced in VTs originating from septal sites, particularly Purkinje sites and the septal outflow tract regions.⁸²

9.2.2 Electrophysiology study

On certain occasions, an EPS is necessary for diagnosis.

9.3 Irregular tachycardias

An irregular ventricular rhythm most commonly indicates AF, multifocal AT, or focal AT/atrial flutter with variable AV conduction, and may occur in the context of both narrow and broad QRS complexes. When AF is associated with rapid ventricular rates, the irregularity of this ventricular response is less easily detected and can be misdiagnosed as a regular SVT.⁸³ If the atrial rate exceeds the ventricular rate, then atrial flutter or AT (focal or multifocal) is usually present. Polymorphic VT and, rarely, monomorphic VT may also be irregular. Occasionally, a junctional, non-re-entrant tachycardia may have a variable rate.

Specifically, the differential diagnosis of an *irregular wide QRS* tachycardia is either pre-excited AF or polymorphic VT, or AT with variable block in the context of aberrancy. Pre-excited AF manifests itself by irregularity, a varying QRS morphology, and a rapid ventricular rate (owing to the short RP of the AP). The changing QRS morphology results from varying degrees of fusion due to activation over both the AP and the AVN, which also result in variation in the width of the delta wave. A further cause of varying QRS morphology in this context will be if more than one antegrade AP is present with intermittent conduction over each. The ventricular rate tends to be higher than in those with non-pre-excited AF.⁸⁴

10 Acute management in the absence of an established diagnosis

10.1 Regular tachycardias

10.1.1 Narrow QRS (≤ 120 ms) tachycardias

Patients with SVT are common and potentially recurrent attenders in emergency departments, with an estimated 50 000 visits each year in the USA.⁸⁵ The initial approach to acute management tends to be non-drug-based, with escalation to intravenous (i.v.) drugs or electrical cardioversion in the absence of early correction (Figure 4).

Recommendations for the acute management of narrow QRS tachycardia in the absence of an established diagnosis

Recommendation	Class ^a	Level ^b
Haemodynamically unstable patients		
Synchronized DC cardioversion is recommended for haemodynamically unstable patients. ^{86–88}	I	B
Haemodynamically stable patients		
A 12 lead ECG during tachycardia is recommended.	I	C
Vagal manoeuvres, preferably in the supine position with leg elevation, are recommended. ^{41,89–91}	I	B
Adenosine (6–18 mg i.v. bolus) is recommended if vagal manoeuvres fail. ^{92–94}	I	B
Verapamil or diltiazem (i.v.) should be considered, if vagal manoeuvres and adenosine fail. ^{92,94–98}	IIa	B
Beta-blockers (i.v. esmolol or metoprolol) should be considered if vagal manoeuvres and adenosine fail. ^{97,99,100}	IIa	C
Synchronized direct-current cardioversion is recommended when drug therapy fails to convert or control the tachycardia. ^{87,88}	I	B

i.v. beta-blockers are contraindicated in the presence of decompensated HF.

i.v. verapamil and diltiazem are contraindicated in the presence of hypotension or HFrEF.

DC = direct current; ECG = electrocardiogram; HF = heart failure; HFrEF = heart failure with reduced ejection fraction; i.v. = intravenous.

^aClass of recommendation.

^bLevel of evidence.

10.1.1.1 Haemodynamically unstable patients

Immediate direct-current (DC) cardioversion is the first choice in haemodynamically compromised patients with narrow QRS tachycardia.^{86–88,101}

10.1.1.2 Haemodynamically stable patients

Vagal manoeuvres can be used to terminate an episode of narrow QRS SVT.⁴¹ The effectiveness of conventional vagal manoeuvres in terminating SVT, when correctly performed, has been reported as between 19 and 54%.^{41,89–91,102,103} Vagal manoeuvres include different techniques used to stimulate the receptors in the internal carotid arteries. This stimulation causes a reflex stimulation of the vagus nerve, which results in the release of acetylcholine, which may in turn slow the electrical impulse through the AVN and slow the heart rate. Many of these manoeuvres can be performed with minimal risk at the bedside or in an office setting, and can be both diagnostic and therapeutic. The *Valsalva manoeuvre* is a safe and internationally recommended first-line emergency treatment for SVT, although a recent Cochrane review found insufficient evidence to support or refute its utility.⁸⁹ The Valsalva manoeuvre has generally been shown to be most effective in adults, and in AVRT rather than AVNRT. A modified

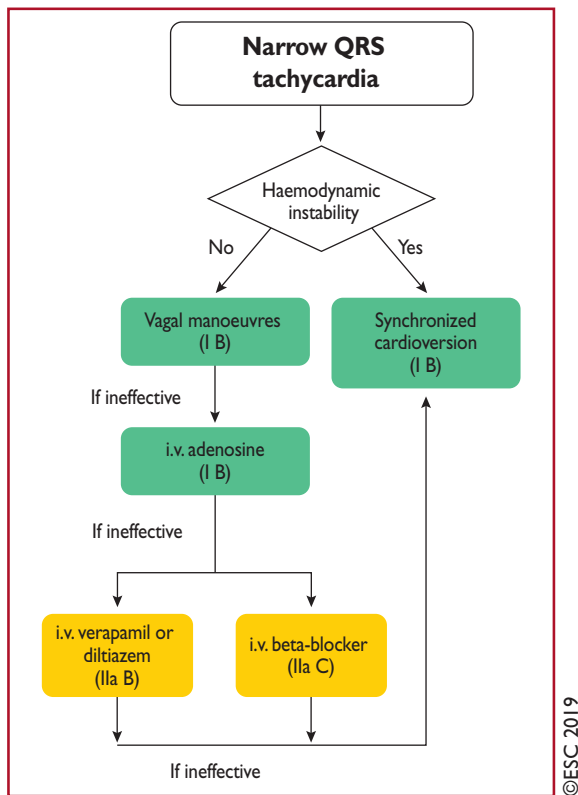

Figure 4 Acute therapy of narrow QRS tachycardia in the absence of an established diagnosis.

i.v. = intravenous.

approach to the Valsalva manoeuvre provides a considerable enhancement of conversion success rates (43 vs. 17% conversion rate).⁴¹ This enhanced method requires the Valsalva to be completed semi-recumbent, with supine repositioning and passive leg raise after the Valsalva strain. Blowing into a 10 mL syringe with sufficient force to move the plunger may standardize the approach.¹⁰⁴ **Carotid sinus massage** is performed with the patient's neck in an extended position, with the head turned away from the side to which pressure is applied. It should always be unilateral as there is a potential risk with bilateral pressure, and it should be limited to 5 s. The patient should be monitored. This technique should be avoided in patients with previous transient ischaemic attack or stroke, and in patients with carotid bruits.³

Other manoeuvres, such as facial immersion in cold water or forceful coughing, are rarely used now.

Adenosine, an endogenous purine nucleoside (6–18 mg i.v. bolus) is the first drug of choice.^{92–94} Pharmacologically relevant electrophysiological influences are mediated through cardiac adenosine A₁ receptors.^{105,106} Clinical EPs have documented progressive dose-related prolongation of AV conduction [due to effects on the atrial–His (AH) interval, and none on the HV interval], culminating in transient AV block that is then responsible for tachycardia termination.¹⁰⁷

The mean dose required for termination is ~6 mg. To achieve efficient rhythm correction, injection should be as a rapid bolus with immediate saline flush. Large, centrally located (e.g. antecubital) veins are likely to deliver more effective drug concentrations to the heart

than smaller distal veins.¹⁰⁸ Dosing should then be incremental, starting at 6 mg in adults followed by 12 mg. An 18 mg dose should then be considered, also taking into account tolerability/side effects in the individual patient. Adenosine has a very short plasma half-life due to enzymatic deamination to inactive inosine being achieved in seconds, with end-organ clinical effects complete within 20–30 s.¹⁰⁷ Thus, repeat administration is safe within 1 min of the last dose.^{2,3} The dose range between patients may be very wide,¹⁰⁷ with >90% success generally expected.^{94,109} Some drugs (e.g. dipyridamole and theophylline) may on occasion affect dose requirements, but any influence of recent intake of caffeinated beverages is disputed.^{110,111}

Transient dyspnoea is common with increased ventilation, and is more likely to result from the stimulation of pulmonary vagal C fibres.¹¹² Facial flushing may occur, associated with vasodilatation and increased skin temperature.¹⁰⁷ Chest pain, variable in terms of radiation over the thorax, may suggest ischaemic or oesophageal origins, and has been associated with increased coronary sinus blood flow so may well be of cardiac origin.¹⁰⁷

Depression of sinoatrial node function is to be expected based on established pharmacology, but prolonged bradycardia is unusual.^{105,107} Nonetheless, adenosine administration should be approached cautiously in those with known sinus node disease.¹¹³ Perceived risks of bradycardia in recipients of denervated orthotropic heart transplants, in whom SVT is common, have prompted a relative contraindication.^{114,115} However, more recent substantive evidence supports adenosine use in this group with no particular cautions.¹¹⁶ AF may occur following adenosine administration as a result of either direct pulmonary vein (PV) triggering¹¹⁷ or increasing heterogeneity of repolarization,¹¹⁸ and appears more commonly associated with AVRT than AVNRT.⁹³ Adenosine may also occasionally cause or accelerate pre-excited atrial arrhythmias.^{119,120}

Clinically important bronchoconstriction has been rarely reported in those receiving i.v. adenosine for SVT,¹²¹ and this observation is further supported by the large experience obtained when adenosine infusions have been given for cardiac stress testing.^{105,122,123} Furthermore, despite inhaled adenosine producing bronchoconstriction in people with asthma,¹²⁴ i.v. administration has had no impact on the airways in clinical experimental studies.¹²⁵ There have been isolated reports of clinically well-documented bronchoconstriction occurring in patients with or without respiratory disease, thus suggesting that care is required in patients with asthma.^{121,126,127} However, adenosine can be used cautiously in those with asthma, although verapamil may be a more appropriate choice in patients with severe asthma.

Adenosine triphosphate may also be used but clinical experience is limited.

Calcium channel blockers (verapamil/diltiazem i.v.) and **beta-blockers** (e.g. esmolol and metoprolol i.v.) are of value, particularly in patients with frequent atrial or ventricular premature beats. Verapamil [0.075–0.15 mg/kg i.v. (average 5–10 mg) over 2 min] or i.v. diltiazem [0.25 mg/kg (average 20 mg) over 2 min] has been shown to terminate SVT in 64–98% of patients, but is associated with a risk of hypotension.^{92,94–98,128} These drugs should be avoided in patients with haemodynamic instability, HF with reduced LV ejection fraction (<40%), a suspicion of VT, or pre-excited AF. Beta-blockers (i.v.), such as short-acting esmolol (0.5 mg/kg i.v. bolus or 0.05–0.3 mg/kg/min infusion) or metoprolol (2.5–15 mg given i.v. in

2.5 mg boluses), are more effective in reducing the tachycardia rate than in terminating it.^{97,99,100,128} Although evidence for the effectiveness of beta-blockers in terminating SVT is limited, they have an excellent safety profile in haemodynamically stable patients. Beta-blockers are contraindicated in patients with decompensated HF. Caution is needed with concomitant use of i.v. calcium channel blockers and beta-blockers, because of possible potentiation of hypotensive and bradycardic effects. In the first clinical trial of *etripamil*, a short-acting L-type calcium channel blocker with a rapid onset of action after intranasal administration, conversion rates from SVT to sinus rhythm ranged from 65–95%.¹²⁹

10.1.2 Wide QRS (120 ms) tachycardias

The acute management of a patient with wide QRS tachycardia depends on the haemodynamic stability of the patient (Figure 5).^{106,130,131}

Recommendations for the acute management of wide QRS tachycardia in the absence of an established diagnosis

Recommendation	Class ^a	Level ^b
Haemodynamically unstable patients		
Synchronized DC cardioversion is recommended in haemodynamically unstable patients. ^{86,130}	I	B
Haemodynamically stable patients		
A 12 lead ECG during tachycardia is recommended.	I	C
Vagal manoeuvres, preferably in the supine position with leg elevation, are recommended.	I	C
Adenosine should be considered if vagal manoeuvres fail and there is no pre-excitation on a resting ECG.	IIa	C
Procainamide (i.v.) should be considered if vagal manoeuvres and adenosine fail. ¹³²	IIa	B
Amiodarone (i.v.) may be considered if vagal manoeuvres and adenosine fail. ¹³²	IIb	B
Synchronized DC cardioversion is recommended if drug therapy fails to convert or control the tachycardia. ^{86,130}	I	B
Verapamil is not recommended in wide QRS-complex tachycardia of unknown aetiology. ^{64,133,134}	III	B

DC = direct current; ECG = electrocardiogram; i.v. = intravenous.

^aClass of recommendation.

^bLevel of evidence.

10.1.2.1 Haemodynamically unstable patients

Haemodynamic instability may occur with any wide QRS tachycardia, regardless of the cause, but is more likely in patients with VT. Synchronized cardioversion is recommended for any persistent wide QRS tachycardia resulting in hypotension, acutely altered mental status, chest pain, acute HF symptoms, or signs of shock.^{86,87}

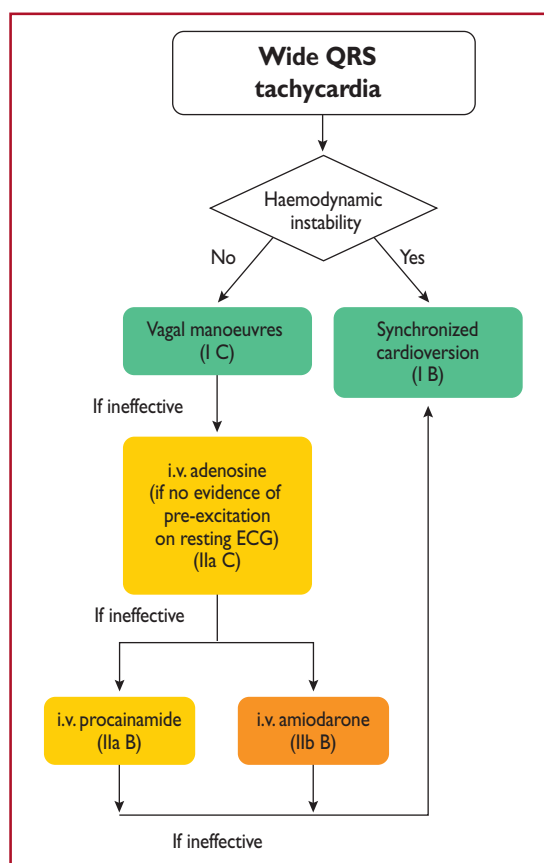

Figure 5 Acute therapy of wide complex tachycardia in the absence of an established diagnosis.

AVRT = atrioventricular re-entrant tachycardia; i.v. = intravenous.

10.1.2.2 Haemodynamically stable patients

In a patient with wide QRS tachycardia who is haemodynamically stable, the response to vagal manoeuvres may provide insight into the mechanism responsible for the arrhythmia. SVT with aberrancy, if definitively identified, may be treated in the same manner as narrow complex SVT, with vagal manoeuvres or drugs (adenosine and other AVN-blocking agents such as beta-blockers or calcium channel blockers).^{117–119,129}

Some drugs used for the diagnosis or treatment of SVT (e.g. verapamil) can cause severe haemodynamic deterioration in patients with a previously stable VT.^{64,133,134} Thus, they should only be used for the treatment of patients in whom the diagnosis of SVT is fully established and secure. Adenosine may be helpful by means of allowing a diagnosis or interrupting an adenosine-sensitive VT, but it must be avoided if pre-excitation on resting ECG suggests a pre-excited tachycardia. There is a risk that in antidromic re-entry, adenosine may precipitate cardiac arrest if there is induction of AF by adenosine, as may occasionally occur.¹³⁵

For pharmacological termination of a haemodynamically stable wide QRS-complex tachycardia of unknown aetiology, i.v. procainamide or amiodarone can be used in-hospital.^{132,136–138} In the PROCAMIO trial¹³² in patients with well-tolerated wide QRS

tachycardia, with or without reduced LV ejection fraction, procainamide was associated with fewer major cardiac adverse events and a higher proportion of tachycardia termination within 40 min compared with amiodarone.

In case the mechanism of the arrhythmia is not fully understood, the arrhythmia should be treated as VT.

10.2 Irregular tachycardias

A wide QRS irregular tachycardia is usually a manifestation of AF. Rarely, polymorphic VT and, very rarely, monomorphic VT may also present as irregular tachycardias. Electrical cardioversion is the acute treatment of choice in irregular pre-excited tachycardias associated with haemodynamic instability. Specific therapy of pre-excited AF is discussed in *section 11*.

If the rhythm is well tolerated with a narrow QRS-complex irregular tachycardia, this should be considered likely to be AF, and rate control with beta-blockers or calcium channel blockers, and elective chemical or electrical cardioversion once thromboprophylaxis is in place, may be appropriate.⁴

11 Specific types of supraventricular tachycardia

11.1 Atrial arrhythmias

11.1.1 Sinus tachycardia

Sinus tachycardia is defined as a sinus rate >100 b.p.m. On the ECG, the P wave is positive in leads I, II, and aVF, and biphasic/negative in lead V1.

11.1.1.1 Physiological sinus tachycardia

The determinants of physiological sinus tachycardia are, by definition, physiological (effort, stress, or pregnancy), and may also arise secondary to other medical conditions or drugs (*Table 10*). The 12 lead ECG shows P-wave morphology typical of normal sinus rhythm. Physiological sinus tachycardia is treated by identifying and eliminating the cause.

11.1.1.2 Inappropriate sinus tachycardia

IST is defined as a fast sinus rhythm (>100 b.p.m.) at rest or minimal activity that is out of proportion with the level of physical, emotional, pathological, or pharmacological stress.¹³⁹ The tachycardia tends to be persistent, and most of the affected patients are young and female, but this disorder is not limited to that population.¹⁴⁰ The underlying

mechanism of IST remains poorly understood and is likely to be multifactorial (e.g. dysautonomia, neurohormonal dysregulation, and intrinsic sinus node hyperactivity). Recently, a gain-of-function mutation of the pacemaker hyperpolarization-activated cyclic nucleotide-gated 4 (*HCN4*) channel has been reported in a familial form of IST.¹⁴¹ There is also evolving evidence that immunoglobulin G anti-beta receptor antibodies are found in IST.¹⁴² The prognosis of IST is generally considered benign¹⁴⁰ and the arrhythmia has not been associated with tachycardia-induced cardiomyopathy.

11.1.1.2.1 Diagnosis. Patients with IST have a wide spectrum of clinical presentations ranging from usually asymptomatic or minimally symptomatic palpitations to dyspnoea, exercise intolerance, dizziness, and light-headedness. The diagnosis of IST is one of exclusion of POTS, sinus re-entrant tachycardia, or focal AT from the superior part of the crista terminalis or right superior PV. Characteristically, 24 h Holter monitoring demonstrates a mean heart rate >90 b.p.m. with an exaggerated heart rate response >100 b.p.m. during waking hours.¹⁴⁰ Tolerance exercise testing might also be considered to document the exaggerated heart rate or blood pressure response to minimal exercise. An EPS is generally not required in making the diagnosis, and should not be routinely performed unless, rarely, sinus node re-entry is suspected.

11.1.1.2.2 Therapy. Reassurance and lifestyle interventions such as exercise training, volume expansion, and avoidance of cardiac stimulants should be tried before drug treatment (*Figure 6*).^{139,143,144} As the prognosis of IST is benign, treatment is aimed at symptom reduction and may not be necessary. Beta-blockers have been used in patients with IST for several years, but may be needed at doses high enough to cause intolerable side effects such as chronic fatigue. Non-dihydropyridine calcium channel blockers may also be used, but at doses that may cause hypotension, and the evidence regarding these drugs is limited.^{139,145} Ivabradine, a selective blocker of the 'pace-maker current' (I_f) in sinoatrial myocytes that directly slow the heart rate, has been found to be safe and effective in several small trials.^{146–150} However, blockade of the I_f may perturb the feedback loop underlying baroreceptor control of autonomic balance, thereby increasing sympathetic activity to the heart.¹⁵¹ If this effect occurred chronically at therapeutic dosages, it would be a matter of concern for its remodelling and pro-arrhythmic potential. Ivabradine should be preferably co-administered with a beta-blocker when possible; this combination may also be more beneficial than each drug alone for IST.¹⁵² Ivabradine should not be taken during pregnancy or

Table 10 Causes of physiological sinus tachycardia

Physiological causes	Emotion, physical exercise, sexual intercourse, pain, pregnancy
Pathological causes	Anxiety, panic attack, anaemia, fever, dehydration, infection, malignancies, hyperthyroidism, hypoglycaemia, pheochromocytoma, Cushing's disease, diabetes mellitus with evidence of autonomic dysfunction, pulmonary embolus, myocardial infarction, pericarditis, valve disease, congestive heart failure, shock
Drugs	Epinephrine, norepinephrine, dopamine, dobutamine, atropine, beta-2 adrenergic receptor agonists (salbutamol), methylxanthines, doxorubicin, daunorubicin, beta-blocker withdrawal
Illicit drugs	Amphetamines, cocaine, lysergic acid diethylamide, psilocybin, ecstasy, crack, cocaine
Other	Caffeine, alcohol

breastfeeding.¹⁵³ As a substrate of cytochrome p450 (CYP) 3A4, ivabradine should be avoided or used with caution with concomitant administration of CYP4A inhibitors (ketoconazole, verapamil, diltiazem, clarithromycin, and grapefruit juice) or inducers (rifampin and carbamazepine).¹⁵⁴ The limited and disappointing evidence, reported from small observational studies, suggests that catheter ablation should not be considered as part of the routine management of most patients with IST.^{155–161}

Recommendations for the therapy of sinus tachycardias

Recommendation	Class ^a	Level ^b
Inappropriate sinus tachycardia		
Evaluation and treatment of reversible causes is recommended. ^{139,144,162}	I	C
Ivabradine alone or in combination with a beta-blocker should be considered in symptomatic patients. ^{146–149,151,152}	IIa	B
Beta-blockers should be considered in symptomatic patients. ^{139,147}	IIa	C
Sinus nodal re-entrant tachycardia		
Non-dihydropyridine calcium channel blockers (verapamil or diltiazem) in the absence of HFrEF, may be considered in symptomatic patients. ¹⁶³	IIb	C
Catheter ablation should be considered in symptomatic patients who do not respond to drug therapy. ^{164–166}	IIa	C
Postural orthostatic tachycardia syndrome		
A regular and progressive exercise programme should be considered. ^{167–169}	IIa	B
The consumption of ≥ 2 –3 L of water and 10–12 g of sodium chloride daily may be considered. ^{170,171}	IIb	C
Midodrine, low-dose non-selective beta-blocker, or pyridostigmine may be considered. ^{167,170,172–174}	IIb	B
Ivabradine may be considered. ¹⁷⁵	IIb	C

HFrEF = heart failure with reduced ejection fraction.

^aClass of recommendation.

^bLevel of evidence.

11.1.1.3 Sinus node re-entrant tachycardia

Sinus node re-entrant tachycardia arises from a re-entry circuit involving the sinus node and, in contrast to IST, is characterized by paroxysmal episodes of tachycardia.¹⁷⁶ This uncommon arrhythmia may be associated with paroxysmal symptoms of palpitation, dizziness, and light-headedness. On the ECG, the polarity and configuration of the P waves are similar to the configuration of sinus P waves.¹⁶³

11.1.1.3.1 Diagnosis. The diagnosis of sinus node re-entrant tachycardia is suspected on ECG and Holter ECG. It can be confirmed with an EPS.

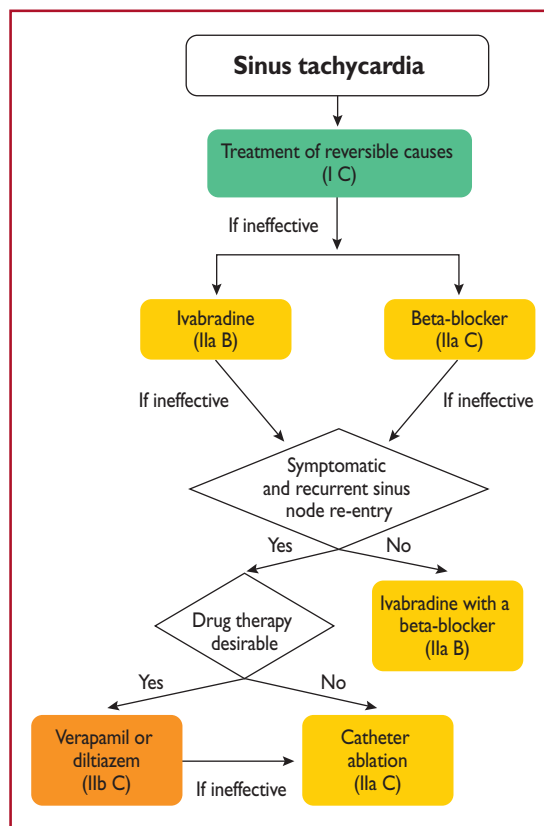

Figure 6 Therapy of sinus tachycardias.

11.1.1.3.2 Therapy. Medical treatment is empirical, and no drugs have been studied in controlled trials. Verapamil and amiodarone have demonstrated variable success, whereas beta-blockers are often ineffective.¹⁶³ Sinus node re-entrant tachycardia may be effectively and safely treated with catheter ablation targeting the site of earliest atrial activation with respect to the P wave. This approach has been shown to be feasible with a good long-term outcome.^{164–166}

11.1.1.4 Postural orthostatic tachycardia syndrome

POTS is defined as a clinical syndrome usually characterized by an increase in heart rate of ≥ 30 b.p.m. when standing for >30 s (or ≥ 40 b.p.m. in individuals aged 12–19 years) and an absence of orthostatic hypotension (>20 mmHg drop in systolic blood pressure).^{177,178}

The prevalence of POTS is 0.2% and it represents the most common cause of orthostatic intolerance in the young,¹⁷⁸ with most patients aged between 15 and 25 years, and $>75\%$ being female. Although the long-term prognosis of POTS has been poorly explored, $\sim 50\%$ of patients spontaneously recover within 1–3 years. A number of mechanisms have been described in patients with POTS, including autonomic nervous system dysfunction, peripheral autonomic denervation, hypovolaemia, hyperadrenergic stimulation, diabetic neuropathy, deconditioning, anxiety, and hypervigilance.^{178–181}

11.1.1.4.1 Diagnosis. POTS is diagnosed during a 10 min active stand test or head-up tilt test with non-invasive haemodynamic

monitoring. The evaluation of a patient suspected of having POTS should eliminate other causes of sinus tachycardia such as hypovolaemia, anaemia, hyperthyroidism, pulmonary embolus, or pheochromocytoma.¹⁷⁸ The clinical history should focus on defining the chronicity of the condition, possible causes of orthostatic tachycardia, modifying factors, impact on daily activities, and potential triggers.

11.1.1.4.2 Therapy. Non-pharmacological treatments should be attempted first in all patients. These include withdrawing medications that might worsen POTS, such as norepinephrine transport inhibitors, increasing blood volume with enhanced salt and fluid intake, reducing venous pooling with compression garments, and limiting deconditioning. Patients should engage in a regular, graduated, and supervised exercise programme featuring aerobic reconditioning with some resistance training for the thighs. Initially, exercise should be restricted to non-upright exercise, including the use of rowing machines and swimming, to minimize orthostatic stress on the heart.^{180–182}

If non-pharmacological approaches prove ineffective, pharmacological therapies may be targeted at specific aspects. Patients strongly suspected of having hypovolaemia should drink ≥ 2 –3 L of water per day, and dietary salt intake should be increased to ~ 10 –12 g/day if tolerated. Midodrine significantly reduces orthostatic tachycardia but to a lesser degree than i.v. saline.¹⁷⁰ Midodrine has a rapid onset with only brief effects and is usually administered three times daily. The drug should only be administered during daytime hours as it can cause supine hypertension. To reduce unpleasant sinus tachycardia and palpitations, low-dose propranolol [10–20 mg per os (p.o.)] acutely lowers standing heart rate and improves symptoms in patients with POTS, while higher doses of propranolol are less well tolerated.¹⁷² Long-acting propranolol does not improve the quality of life of patients with POTS.¹⁶⁷ Non-selective beta-blockers are preferable because they additionally block epinephrine-mediated beta-2-vasodilation, but other beta-blockers have not been adequately studied. Pyridostigmine, a cholinergic agonist that works by inhibiting acetylcholinesterase, can increase parasympathetic autonomic tone and has a lower risk of hypertension compared with other medications. Potential side effects include abdominal cramping, diarrhoea, and muscle cramps.^{173,174} Ivabradine slows sinus rates without affecting blood pressure, and in an open-label study $\sim 60\%$ of patients with POTS had symptomatic improvement.¹⁷⁵ Ivabradine should ideally be administered with concomitant beta-blockers for long-term therapy.¹⁵¹

11.1.2 Focal atrial tachycardia

Focal AT is defined as an organized atrial rhythm ≥ 100 b.p.m. initiated from a discrete origin and spreading over both atria in a centrifugal pattern. The ventricular rate varies, depending on AV nodal conduction. In asymptomatic young people (<50 years of age), the prevalence of focal AT has been reported to be as low as 0.34% with an increased prevalence of 0.46% in symptomatic arrhythmia patients.¹⁸³ Most studies have reported no influence of sex.

Symptoms may include palpitations, shortness of breath, chest pain, and rarely syncope or presyncope. The arrhythmia may be

sustained or incessant. Dynamic forms with recurrent interruptions and reinitiations may be frequent.

In patients with PV-related AT, the focus is located at the ostium of the vein (or within 1 cm of the designated ostium)¹⁸⁴ rather than further distally (2–4 cm).¹⁸⁵

11.1.2.1 Diagnosis

P wave identification from a 12 lead ECG recording during tachycardia is critical (Figure 7). Depending on the AV conduction and AT rate, the P waves may be hidden in the QRS or T waves. The P waves are monomorphic with stable CL, which helps to rule out organized AF. Adenosine injection can help by slowing the ventricular rate or, less frequently, by terminating focal AT. A discrete P wave with an intervening isoelectric interval suggests a focal AT. However, distinguishing focal from macro-re-entrant arrhythmias by surface ECG is not always possible. The presence of an isoelectric line does not rule out a macro-re-entrant mechanism, particularly in the presence of scar atrial tissue (from structural heart disease or previous extensive ablation/surgery procedures). In a normal heart and in the absence of previous ablation, the usual ECG localization rules apply,¹⁸⁶ but their value in localizing the origin of the arrhythmia is also limited in this context. Focal AT may arise from any site in both atria, but particular sites of predilection in the normal heart rate are the crista terminalis, the tricuspid and mitral valve annulus, and within the thoracic veins joining the atria.^{46,186} A negative P wave in lead I and aVL suggests an LA origin. V1 is negative when the arrhythmia source or exit is in the lateral right atrium, while septal right atrial (RA) and LA origins show biphasic or positive P waves (Figure 7). Negative P waves in the inferior leads suggest a caudal origin, whereas positive P waves in those leads favour a superior location.

11.1.2.2 Acute therapy

Hard data for an evidence-based choice of drugs for the acute therapy of focal AT are scarce. In general, acute therapy may be initiated with beta-blockers or calcium channel blockers, which may terminate focal ATs or slow the ventricular rate (Figure 8).^{92,94,187,188} Adenosine (i.v.) may terminate AT [delayed after-depolarizations (DAD)-triggered AT], but the tachycardia may also continue with AV block. Class IA, IC, and III drugs may also be effective, by prolonging refractoriness or suppressing automaticity.^{189–191} Amiodarone may also be used for cardioversion or slowing of the ventricular rate,¹⁹² but the efficacy of rate control is unproven in critically ill patients with atrial arrhythmias.¹⁹³ DC cardioversion is usually effective in acutely terminating the tachycardia, irrespective of the mechanism. However, in incessant forms of focal AT due to enhanced automaticity, the arrhythmia reinitiates, and repeating DC cardioversion is unlikely to be appropriate.

11.1.2.3 Catheter ablation

Catheter ablation is the treatment of choice for recurrent focal AT, especially for incessant AT due to which TCM ensues (Figure 9).¹⁹⁶ Distinguishing macro-re-entrant from focal ATs is critical for the ablation strategy. Focal ATs, as well as localized/micro-re-entry ATs, display a centrifugal activation pattern that spreads throughout the atria. Mapping and ablation of focal ATs is based on determining the earliest activation site. In PV-related AT, focal ablation may be performed, but electrical isolation of both

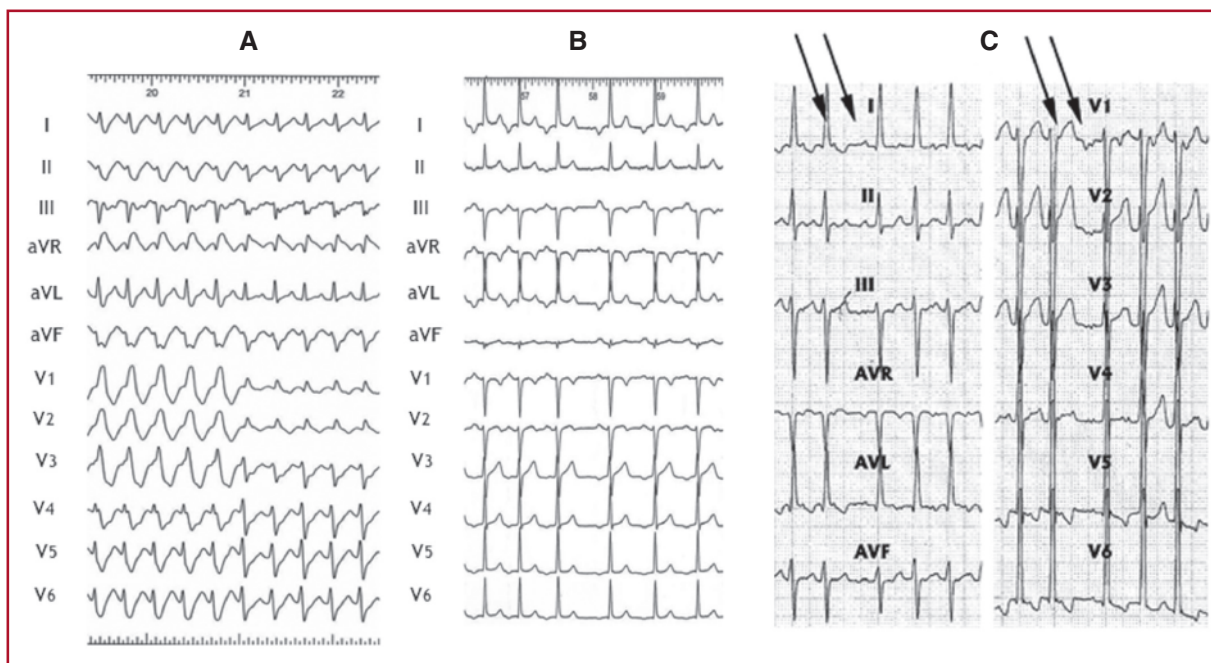

Figure 7 Focal atrial tachycardia. (A) Focal atrial tachycardia originating at the lateral right atrium conducted initially with full and then incomplete right branch bundle block aberration. (B) Focal atrial tachycardia originating at the left atrium (left superior pulmonary vein). (C) Focal atrial tachycardia from the right atrial appendage. Atrioventricular dissociation during carotid sinus massage (P waves indicated by arrows).

Recommendations for the therapy of focal atrial tachycardia

Recommendation	Class ^a	Level ^b
Acute therapy		
Haemodynamically unstable patients		
Synchronized DC cardioversion is recommended for haemodynamically unstable patients. ^{86–88}	I	B
Haemodynamically stable patients		
Adenosine (6–18 mg i.v. bolus) should be considered. ^{92–94}	IIa	B
Beta-blockers (i.v. esmolol or metoprolol) should be considered in the absence of decompensated HF, if adenosine fails. ^{187,188}	IIa	C
Verapamil or diltiazem (i.v.) should be considered for haemodynamically stable patients in the absence of hypotension or HFrEF, if adenosine fails. ^{92,94}	IIa	C
If the above measures fail, the following may be used:		
<ul style="list-style-type: none"> ● i.v. ibutilide¹⁹¹; ● or i.v. flecainide or propafenone^{189,190}; ● or i.v. amiodarone.¹⁹² 	IIb	C
Synchronized DC cardioversion is recommended when drug therapy fails to convert or control the tachycardia. ^{87,88}	I	B
Chronic therapy		
Catheter ablation is recommended for recurrent focal AT, especially if incessant or causing TCM. ^{184,187,194–197}	I	B
Beta-blockers or non-dihydropyridine calcium channel blockers (verapamil or diltiazem in the absence of HFrEF), or propafenone or flecainide in the absence of structural or ischaemic heart disease, should be considered if ablation is not desirable or feasible. ^{188–190,198}	IIa	C
Ivabradine with a beta-blocker may be considered if the above measures fail. ^{199,200}	IIb	C
Amiodarone may be considered if the above measures fail. ^{201,202}	IIb	C

i.v. verapamil and diltiazem are contraindicated in the presence of hypotension or HFrEF.

i.v. beta-blockers are contraindicated in the presence of decompensated heart failure.

i.v. ibutilide is contraindicated in patients with prolonged QTc interval.

i.v. flecainide and propafenone are contraindicated in patients with ischaemic or structural heart disease. They also prolong the QTc interval but much less than class III agents.

i.v. amiodarone prolongs the QTc but torsades des pointes is rare.

AT = atrial tachycardia; DC = direct current; HF = heart failure; HFrEF = heart failure with reduced ejection fraction; i.v. = intravenous; TCM = tachycardiomyopathy.

^aClass of recommendation.

^bLevel of evidence.

the culprit PV along with other PVs may be preferred. Catheter ablation is reported to have a 75–100% success rate.^{184,187,194–197} Table 11 presents a synopsis of success rates and complications of catheter ablation for the most common SVTs in the current era.^{11–13,203–208}

11.1.2.4 Chronic therapy

Studies addressing chronic therapy are also limited, and thus firm conclusions cannot be drawn. Beta-blockers and calcium channel

blockers may be effective, and there is a low risk of side effects (Figure 9).¹⁸⁸ Class IC drugs may be effective if first-line therapy has failed.^{189,190,198} Ivabradine may also be effective in focal AT,^{199,200} and ideally should be given with a beta-blocker. Amiodarone has been tried in the young and paediatric populations,^{201,202} and theoretically should be attractive in patients with impaired LV function. However, its long-term efficacy is limited by its side effects.

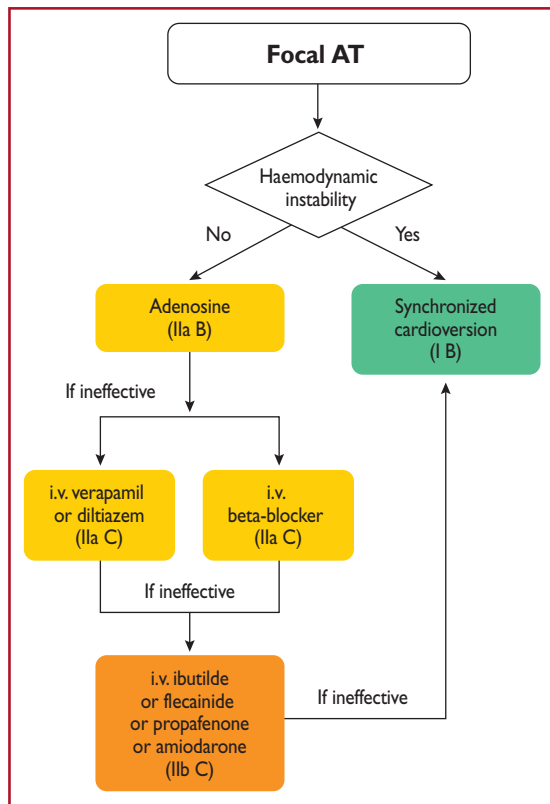

Figure 8 Acute therapy of focal atrial tachycardia. AT = atrial tachycardia; i.v. = intravenous.

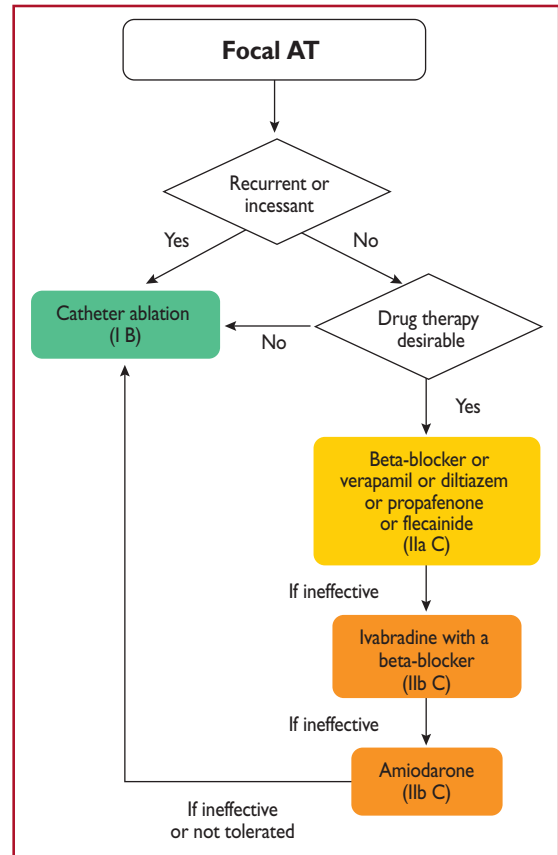

Figure 9 Chronic therapy of focal atrial tachycardia. AT = atrial tachycardia.

Table 11 Average success and complication rates of catheter ablation for supraventricular tachycardia

	Acute success (%)	Recurrence (%)	Complications (%)	Mortality (%)
Focal AT	85	20	1.4 ^a	0.1
Cavotricuspid-dependent atrial flutter	95	10	2 ^b	0.2
AVNRT	97	2	0.3 ^c	0.01
AVRT	92	8	1.5 ^d	0.1

Success rates, recurrence, and complications for focal atrial tachycardia and atrioventricular re-entrant tachycardia vary, being dependent on the location of the focus or pathway, respectively.^{11–13,203–208}

^aVascular complications, AV block, and pericardial effusion.

^bVascular complications, stroke, myocardial infarction, and pericardial effusion.

^cVascular complications, AV block, and pericardial effusion.

^dVascular complications, AV block, myocardial infarction, pulmonary thromboembolism, and pericardial effusion.

AT = atrial tachycardia; AV = atrioventricular; AVNRT = atrioventricular nodal re-entrant tachycardia; AVRT = atrioventricular re-entrant tachycardia.

11.1.3 Multifocal atrial tachycardia

Multifocal AT is defined as a rapid, irregular rhythm with at least three distinct morphologies of P waves on the surface ECG. Multifocal AT is commonly associated with underlying conditions, including pulmonary disease, pulmonary hypertension, coronary disease, and valvular heart disease, as well as hypomagnesaemia and theophylline therapy.²⁰⁹ It may also be seen in healthy infants under 1 year of age, and carries a good prognosis in the absence of underlying cardiac disease.²¹⁰

It may be difficult to distinguish multifocal AT from AF on a single ECG trace, so a 12 lead ECG is indicated to confirm the diagnosis. On the ECG, the atrial rate is >100 b.p.m. Unlike AF, there is a distinct isoelectric period between visible P waves. The PP, PR, and RR intervals are variable. Although it is assumed that the variability of P-wave morphology implies a multifocal origin, there have been very few mapping studies of multifocal AT.

11.1.3.1 Therapy

The first-line treatment is management of the underlying condition. Magnesium (i.v.) may also be helpful in patients, even in those with normal magnesium levels.²¹¹ Antiarrhythmic medications, in general, are not helpful in suppressing multifocal AT.²⁰⁹ Management often involves slowing conduction at the AVN level to control heart rate. Verapamil has some efficacy in patients with multifocal AT who do not have ventricular dysfunction, sinus node dysfunction, or AV block.^{212,213} Metoprolol has been found to be superior to verapamil²¹⁴ and beta-blockers can be used with caution to treat multifocal AT in the absence of respiratory decompensation, sinus node

Recommendations for the therapy of multifocal atrial tachycardia

Recommendation	Class ^a	Level ^b
Acute therapy		
Treatment of an underlying condition is recommended as a first step, if feasible. ²⁰⁹	I	C
i.v. beta-blockers, or i.v. non-dihydropyridine calcium channel blockers (verapamil or diltiazem) should be considered. ^{213,214}	IIa	B
Chronic therapy		
Oral verapamil or diltiazem should be considered for patients with recurrent symptomatic multifocal AT in the absence of HFrEF. ^{217,218}	IIa	B
A selective beta-blocker should be considered for patients with recurrent symptomatic multifocal AT. ^{214,219}	IIa	B
AV nodal ablation followed by pacing (preferable biventricular or His-bundle pacing) should be considered for patients with LV dysfunction due to recurrent multifocal AT refractory to drug therapy. ²¹⁶	IIa	C

AT = atrial tachycardia; HF = heart failure; HFrEF = heart failure with reduced ejection fraction; i.v. = intravenous; LV = left ventricular.

i.v. verapamil and diltiazem are contraindicated in the presence of hypotension or HFrEF.

i.v. beta-blockers are contraindicated in the presence of decompensated heart failure.

^aClass of recommendation.

^bLevel of evidence.

dysfunction, or AV block. There has also been a case report on the successful use of ibutilide.²¹⁵ In symptomatic and medically refractory cases in which LV deterioration is seen, AV nodal modification may be used for the control of ventricular rate.²¹⁶

11.1.4 Macro-re-entrant atrial tachycardias

Atrial flutter and focal AT are traditionally defined according to the ECG appearance: continuous regular electrical activity, most commonly a saw-tooth pattern, vs. discrete P waves with an isoelectric line in between. ECGs with flutter-like appearances are mostly due to macro-re-entrant atrial circuits but micro-re-entry is also possible. However, MRATs with a significant part of the activation of the circuit in protected areas may display a focal AT pattern, with discrete P waves.²²⁰

11.1.4.1 Cavotricuspid isthmus-dependent macro-re-entrant AT

11.1.4.1.1 Typical atrial flutter: common (counter-clockwise) and reverse (clockwise). Typical common atrial flutter is the most frequent cavotricuspid isthmus (CTI)-dependent flutter, i.e. a macro-re-entry circuit around the tricuspid annulus using the CTI as a critical passage at the inferior boundary. Activation goes downward in the RA free wall, through the CTI, and ascends in the right septum. Activation of the LA is passive. The upper part of the circuit may be anterior or posterior to the superior vena cava. This activation is also known as counter-clockwise (or anticlockwise) when seen from the apex. When the circuit is activated in the opposite direction, i.e. clockwise, it results in a different ECG pattern, then called typical reverse flutter.

11.1.4.1.2 Diagnosis. In counter-clockwise flutter, the circuit results in regular atrial activation from 250–330 b.p.m., with negative saw-tooth waves in inferior leads and positive waves in V1 (Figure 10). In

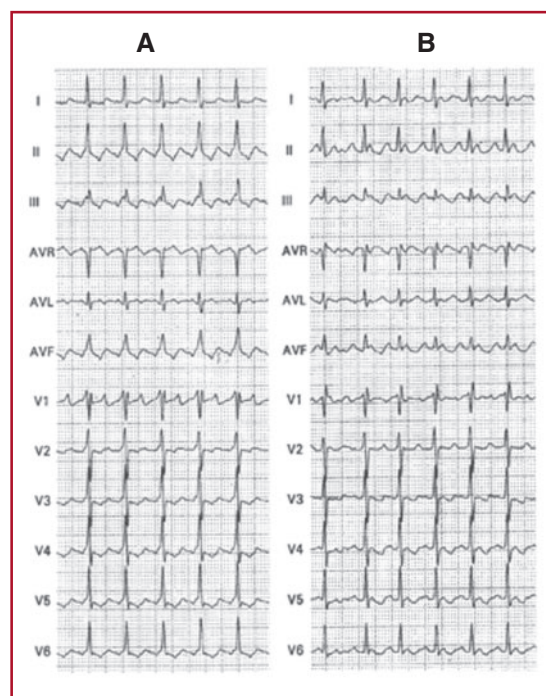

Figure 10 Counter-clockwise (A) and clockwise (B) atrial flutter with 2:1 atrioventricular conduction.

clockwise flutter, ECG flutter waves in inferior leads look positive and broad, and are frequently bimodal negative in V1.^{220,221} Typical atrial flutter has a strong reproducible anatomical dependence,²²² resulting in the morphological reproducibility of the ECG. However, this well-recognized ECG pattern may be significantly changed when atrial activation has been modified, as it is in cardiac surgery involving atrial tissue, after extensive radiofrequency ablation, or in advanced atrial disease.^{223,224} Antiarrhythmic drugs may also modify the typical ECG pattern.²²⁵ In these situations, an atypical ECG does not rule out a circuit of typical flutter using the CTI.²²⁶

Typical flutter is related to AF in clinical practice, with both being associated with similar clinical settings and coexisting in the same patients: AF may trigger atrial flutter, and after typical flutter ablation AF is frequent.^{223,227–229} Typical flutter may also frequently occur in patients treated for AF with class IC drugs or amiodarone. In this case, flutter rate may be reduced to <200 b.p.m. facilitating 1:1 AV conduction. The action of antiarrhythmic drugs on ventricular activation may result in wide QRS tachycardia.^{230–232}

Beyond symptoms associated with high-rate and loss of atrial kick, reversible systolic dysfunction and subsequent TCM are not unusual.^{233,234}

11.1.4.1.3 Acute therapy. Although the first step should be rate control when the ventricular rate is high, this may be difficult to achieve. AV nodal blocking drugs,^{235–238} including amiodarone applied mostly in HF or critically ill patients,^{239,240} may be of help, but cardioversion may be necessary (Figure 11).

In some cases, presenting with 2:1 AV block, the diagnosis of atrial flutter may not be obvious on the ECG. In these situations, i.v. adenosine may increase the degree of AV block and reveal the typical ECG pattern. However, adenosine can produce a rebound increase in AV conduction to 1:1 and may also precipitate AF.^{271,272} Thus, it should only be used if deemed necessary for diagnosis and resuscitation equipment is available.

Rate control should be the first step in very symptomatic patients with rapid ventricular rates. This is a particularly difficult goal in atrial

Recommendations for the therapy of macro–re-entrant atrial arrhythmias

Recommendations	Class ^a	Level ^b
Anticoagulation, as in AF, is recommended for patients with atrial flutter and concomitant AF. ⁴	I	B
Patients with atrial flutter without AF should be considered for anticoagulation, but the threshold for initiation has not been established. ^{241–247}	IIa	C
Acute therapy		
Haemodynamically unstable patients		
Synchronized DC cardioversion is recommended for haemodynamically unstable patients. ^{248,249}	I	B
Haemodynamically stable patients		
i.v. ibutilide or i.v. or oral (in-hospital) dofetilide are recommended for conversion to sinus rhythm. ^{250–257}	I	B
Low-energy (≤100 J biphasic) electrical cardioversion is recommended for conversion to sinus rhythm. ^{248,249}	I	B
High-rate atrial pacing is recommended for termination of atrial flutter in the presence of an implanted pacemaker or defibrillator. ^{258–260}	I	B
i.v. beta-blockers or non-dihydropyridine calcium channel blockers (verapamil or diltiazem) (i.v.), should be considered for control of rapid ventricular rate. ^{235–238}	IIa	B
Invasive and non-invasive high-rate atrial pacing may be considered for termination of atrial flutter. ^{258,261}	IIb	B
i.v. amiodarone may be tried if the above are not available or desirable. ^{239,240}	IIb	C
Propafenone and flecainide are not recommended for conversion to sinus rhythm. ²⁵⁰	III	B
Chronic therapy		
Catheter ablation should be considered after the first episode of symptomatic typical atrial flutter. ^{262,263}	IIa	B
Catheter ablation is recommended for symptomatic, recurrent episodes of CTI-dependent flutter. ^{262–264}	I	A
Catheter ablation in experienced centres is recommended for symptomatic, recurrent episodes of non-CTI-dependent flutter. ^{224,265–269}	I	B
Catheter ablation is recommended in patients with persistent atrial flutter or in the presence of depressed LV systolic function due to TCM. ^{233,234}	I	B
Beta-blockers or non-dihydropyridine calcium channel blockers (verapamil or diltiazem, in the absence HFrEF) should be considered if ablation is not desirable or feasible. ^{237,270}	IIa	C
Amiodarone may be considered to maintain sinus rhythm if the above measures fail. ²⁶³	IIb	C
AV nodal ablation with subsequent pacing ('ablate and pace'), either biventricular or His-bundle pacing, should be considered if all the above fail and the patient has symptomatic persistent macro-re-entrant atrial arrhythmias with fast ventricular rates.	IIa	C

i.v. verapamil and diltiazem are contraindicated in the presence of hypotension or HFrEF.

i.v. beta-blockers are contraindicated in the presence of decompensated heart failure.

i.v. ibutilide, and i.v. and oral dofetilide are contraindicated in patients with prolonged QTc interval.

i.v. amiodarone prolongs the QTc but torsades des pointes is rare.

AF = atrial fibrillation; AV = atrioventricular; CTI = cavotricuspid isthmus; DC = direct current; HFrEF = heart failure with reduced ejection fraction; i.v. = intravenous; LV = left ventricular; TCM = tachycardiomyopathy.

^aClass of recommendation.

^bLevel of evidence.

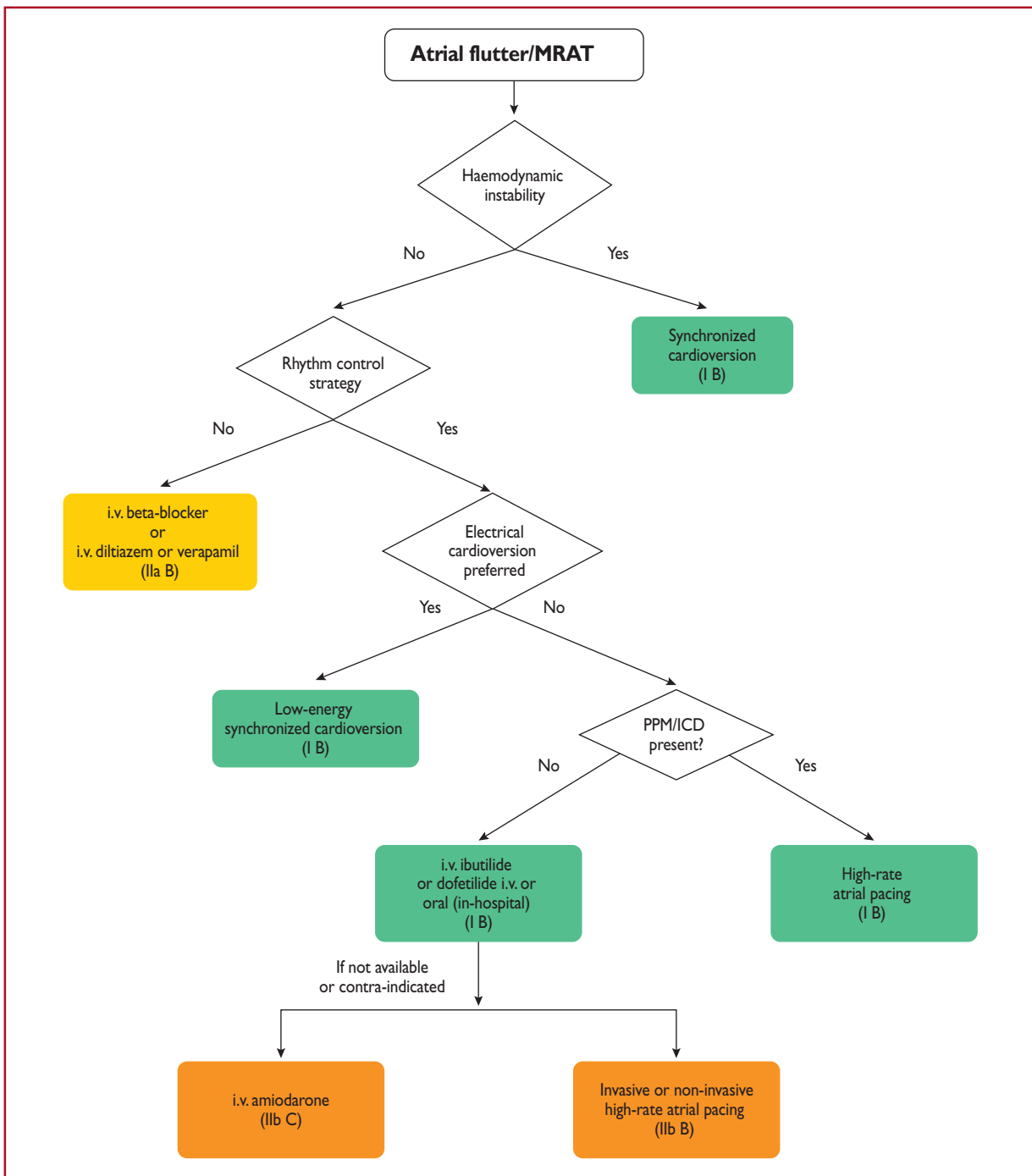

©ESC 2019

Figure 11 Acute therapy of stable atrial flutter or macro-re-entrant atrial tachycardia.

ICD = implantable cardioverter defibrillator; i.v. = intravenous; MRAT = macro-re-entrant atrial tachycardia; PPM: permanent pacemaker.

flutter and even the combination of AVN-blocking drugs (digoxin, beta-blockers, and calcium channel blockers)^{235–238} may fail, making cardioversion to sinus rhythm necessary. Dofetilide and ibutilide, pure class III antiarrhythmic drugs, are generally effective in interrupting atrial flutter in i.v. administration (dofetilide may be also given orally for this purpose), while class IA and IC drugs have little or no effect.^{250–257} Class IC antiarrhythmic drugs should not be used in the absence of AV-blocking agents because of the risk of slowing the atrial rate, which may result in 1:1 AV conduction.^{273,274} Amiodarone may not be very effective acutely to re-establish sinus rhythm, but it does help to control the ventricular rate if it is too fast.^{275,276} Low-energy electrical cardioversion is commonly used with haemodynamic compromise or after failure of previous actions, but it could be the first choice due to its high efficacy. Electrical cardioversion for atrial flutter is more effective and less energy is required, compared with AF.^{248,249} When atrial electrodes are in place, high-rate stimulation can be used to convert flutter, sometimes through AF.^{258,259} If pacing induces AF, this may allow better control of the ventricular rate than flutter. Atrial stimulation can also be done with percutaneous endocardial electrodes or from the oesophagus; this is mostly done in paediatrics.²⁶¹ Pre-treatment with procainamide may facilitate conversion of atrial flutter by atrial pacing.²⁷⁷ Data on pre-cardioversion anticoagulation are lacking, but most probably patients should be treated the same as those with AF.^{4,278}

11.1.4.1.4 Catheter ablation. Catheter ablation is the most effective therapy to maintain sinus rhythm, and is clearly superior to amiodarone.^{262,263} Ablation of CTI with confirmed bidirectional conduction block results in a <10% rate of recurrence.²⁷⁹ However, the incidence of AF is high in the long-term.²⁸⁰ When typical CTI-dependent atrial flutter ensues during antiarrhythmic drug therapy (class IC or amiodarone) for AF, CTI ablation is a reasonable choice to ensure that antiarrhythmic drugs can be continued for AF control.^{262,263}

Although no procedure-related mortality had been detected in early studies,^{203,204} in recent studies, mortality and stroke rates of 0.2–0.34 and 0.19–0.5%, respectively, have been reported (Table 11).^{12,206} In a recent registry, ablation for flutter had a higher mortality than that for AF (0.3 vs. 0.05%), but this might have been due to the comorbidities or advanced ages of patients referred for flutter ablation.²⁰⁷

11.1.4.1.5 Chronic therapy. Rate control is part of the therapeutic approach, using AV nodal blocking agents such as diltiazem, verapamil, or beta-blockers (Figure 12). When ablation is not feasible or the patient's preference, antiarrhythmic drugs may also be used to maintain sinus rhythm. Dofetilide²⁵⁷ and sotalol²⁸¹ are useful, but there are concerns about pro-arrhythmia. Amiodarone may have a role,²⁶³ but it should be restricted to cases of HF or significant structural heart disease.

11.1.4.1.6 Anticoagulation. Data about the embolic risk of atrial flutter have usually been derived in the presence of concomitant AF, thus making individualized risk stratification difficult. Left atrial (LA) appendage 'stunning' and thrombi seem to be lower

compared with those in AF.^{247,282} The thrombo-embolic risk of atrial flutter, although lower than that of AF,²⁴⁶ is still significant.^{241–244} That, together with the association with AF, justifies thromboprophylaxis, and anticoagulation has been recommended as in AF.^{2,3} These recommendations extend to the acute setting for cardioversion when flutter lasts for >48 h.²⁷⁸ However, it should be noted that there is a lack of prospective, dedicated, randomized studies on the subject. Furthermore, the value of the CHA₂DS₂-VASc [Cardiac failure, Hypertension, Age ≥75 (Doubled), Diabetes, Stroke (Doubled) – Vascular disease, Age 65–74 and Sex category (Female)] score in preventing ischaemic stroke in patients with atrial flutter has not been established,²⁴⁵ and in patients without concomitant AF the threshold for the initiation of anticoagulation appears to be higher than that for patients with AF.²⁴⁶

11.1.4.1.7 Other cavotricuspid isthmus-dependent macro-reentrant atrial tachycardia. An atypical ECG pattern may not exclude CTI-dependent MRAT.²⁸³ Lower-loop re-entry refers to a circuit rotating around the inferior vena cava instead of around the tricuspid annulus. It may be clockwise or counter-clockwise.^{284,285} When rotating counter-clockwise, it might be considered a variant of typical counter-clockwise flutter with a caudal shift of the cranial turning point posterior to the entry of the superior vena cava, resulting in a similar ECG appearance. 'Figure-of-eight double-loop re-entry' may also occur around the inferior vena cava and tricuspid annulus, and mimic typical clockwise atrial flutter.²⁸⁵ Other circuits using part of the CTI or even restricted inside it, are in essence CTI-dependent with a similar ECG appearance to typical common flutter.^{286,287}

11.1.4.2 Non-cavotricuspid isthmus-dependent macro-reentrant atrial tachycardia

The terms non-CTI-dependent MRAT and atypical flutter are used interchangeably, and describe flutter waves in the ECG not suggestive of typical circuits. The pitfall with this use comes from the atypical ECG that may happen when typical circuits develop in diseased atria, most frequently after surgery or extensive ablation, or under the effects of antiarrhythmic drugs. Conversely, upper-loop re-entry may mimic a typical flutter ECG pattern without being CTI-dependent.²⁸³ True atypical flutter is actually a *post hoc* diagnosis when the circuit has been outlined and dependence on CTI has been ruled out.

11.1.4.2.1 Right atrium macro-reentrant atrial tachycardia. Atrial sutures and patches used for complex congenital heart disease surgery, together with progressive atrial damage, create multiple obstacles and protected isthmuses that constitute the substrate for complex and multiple MRAT.^{288,289} This usually happens around RA free wall scars. However, in patients with complex congenital heart disease, the presence of extensive atrial scars hinders the differential diagnosis of focal or MRAT.²⁹⁰

Figure-of-eight double-loop tachycardias mimicking the ECG pattern of a common atrial flutter may also occur following surgical atriotomy.²⁹¹

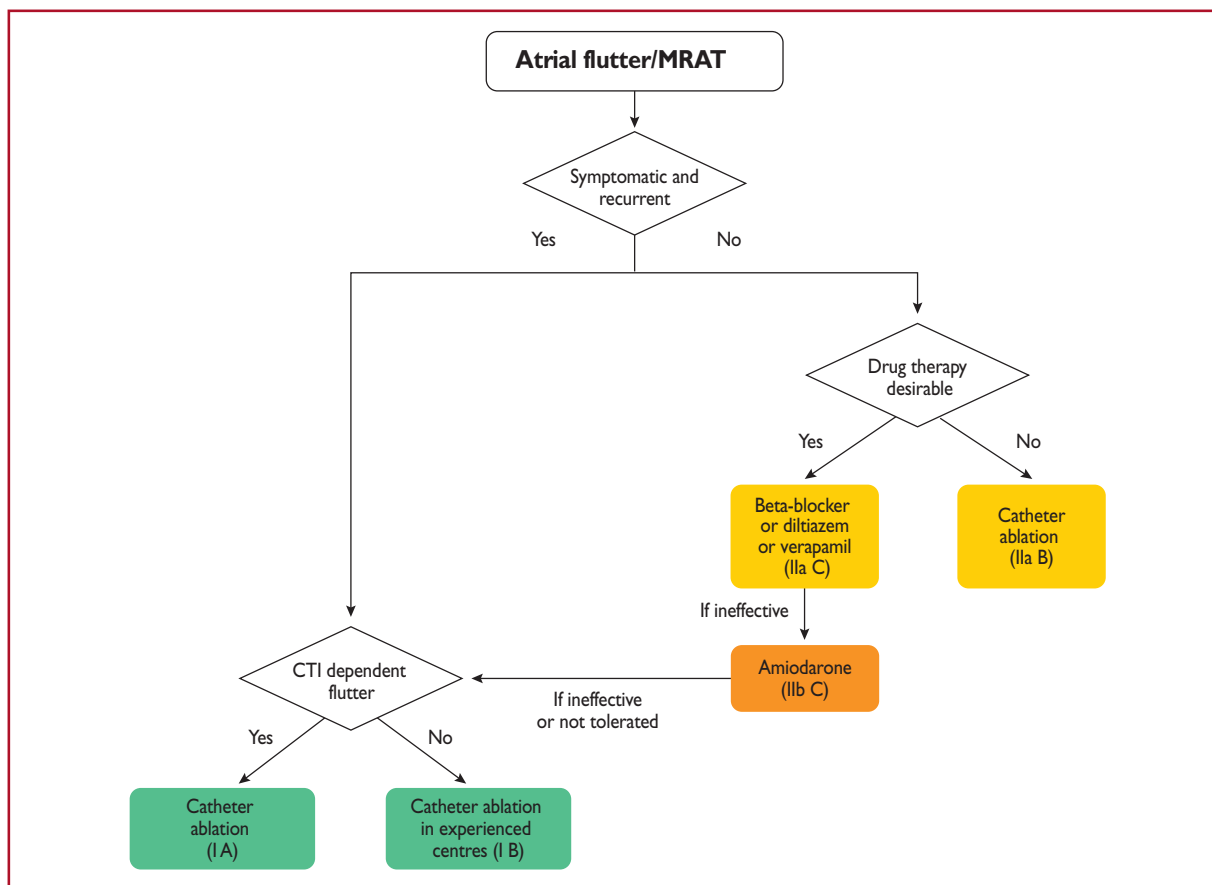

©ESC 2019

Figure 12 Chronic therapy of atrial flutter/macro-re-entrant atrial tachycardia. CTI = cavotricuspid isthmus; MRAT = macro-re-entrant atrial tachycardia.

RA MRAT may also occur in the absence of previous intervention. Most of these are sustained around areas of 'electrical silence' in the RA free wall, probably due to fibrosis.^{224,264,266} Atypical atrial flutter could also arise from upper loop re-entry in the right atrium with conduction through the gap in the crista terminalis.²⁶⁹

Rate control is often difficult due to the regularity and usually slow rate of the tachycardia. Antiarrhythmic drugs are often ineffective, or their use is limited because of structural heart disease and comorbidities. Radiofrequency ablation of often several critical isthmuses is the most effective treatment. Circuits around scars of longitudinal atriotomy can be mapped and ablated with good long-term results.^{267,292} However, owing to the complexity of possible substrates and difficulty of reaching critical isthmuses, ablation procedures for these patients should be restricted to experienced operators and centres.

11.1.4.2.2 Left atrium macro-re-entrant atrial tachycardia. Circuits sustaining LA atypical flutter/MRAT are most usually due to electrically silent areas of abnormal tissue, following medical interventions or progressive atrial degeneration/fibrosis.²⁶⁸ Anatomical obstacles such as the ostia of PVs, and mitral annulus, are often involved.

Owing to its widespread use, AF ablation is the procedure that frequently causes the lesions able to sustain re-entry circuits, usually after linear ablation or extensive defragmentation. Pre-existing atrial disease is also predictive of macro-re-entry.²⁹³ Localized segmental PV disconnection may cause focal tachycardias,²⁹⁴ and circumferential antral ablation may also create MRAT due to gaps in the lines.^{295–299} AT due to a small re-entrant circuit after ablation of AF may possibly be distinguished from macro-re-entry by a shorter P-wave duration. RA MRATs have a higher incidence of negative polarity in at least one pre-cordial lead compared with LA macro-re-entry.^{300–302}

Atrial circuits are also created after surgery for different conditions, including mitral valve disease, and are related to incisions or cannulation.³⁰³ Surgery to treat AF may also result in macro-re-entry circuits and focal AT.³⁰⁴

Circuits causing atypical left MRAT may also occur in the LA without prior intervention, commonly, but not invariably, associated with significant left heart disease.³⁰⁵ These are based on areas of electrical silence, probably due to fibrosis, engaging anatomical obstacles such as the ostia of the PVs or the mitral annulus, and may be ablated by interrupting critical isthmuses.^{265,306} Circuits may also happen in the LA septum due to slow conduction caused by atrial disease or antiarrhythmic drugs.³⁰⁷

Peri-mitral flutter, sometimes incorporating silent areas at the roof of the LA, is ablated in a similar way to peri-tricuspid circuits. However, the deployment of a stable line of block at critical isthmuses is more challenging.^{308–310} Circuits around the PVs are also frequently recognized and ablated.^{280,295,296} Intervention to treat these tachycardias after the initial procedure should be delayed, if possible, for ≥ 3 months. As part of the maturation process of the deployed lesions, some tachycardias may be transient in nature,³¹¹ and initial rate control and/or use of antiarrhythmic drugs is favoured.

11.2 Atrioventricular junctional arrhythmias

11.2.1 Atrioventricular nodal re-entrant tachycardia

AVNRT denotes re-entry in the area of the AVN, but the exact circuit remains elusive. The AVN is a three-dimensional structure with greater variability in the space constant of tissue, and poor gap junction connectivity due to differential expression of connexin isoforms, conditions that provide an explanation for dual conduction and nodal re-entrant arrhythmogenesis.^{312–314} There has also been considerable histological and electrophysiological evidence that the right and left inferior extensions of the human AVN, and the atrionodal inputs that they facilitate, may provide the anatomical substrate for the slow pathway.^{315,316} Thus, comprehensive models of the tachycardia

circuit for all forms of AVNRT based on the concept of atrionodal inputs have been proposed.^{47,317}

Onset of AVNRT seems to occur bimodally over time. In many patients, attacks indeed manifest early in life, whereas in a substantial proportion of patients AVNRT starts later, e.g. in the fourth or fifth decade of life.³¹⁸ One-half of the patients with minimal symptoms and short-lived, infrequent episodes of tachycardia may become asymptomatic within the next 13 years.³¹⁹ AVNRT may result in AF that usually, although not invariably, is eliminated following catheter ablation of AVNRT.³²⁰ Familial AVNRT should be considered.³²¹

11.2.1.1 Diagnosis

11.2.1.1.1 12 lead electrocardiogram during tachycardia. Typically, AVNRT is a narrow complex tachycardia, i.e. QRS duration < 120 ms, unless there is aberrant conduction, which is usually of the RBBB type, or a previous conduction defect exists (*Figure 13*). AV dissociation is exceptionally uncommon, but it can occur as neither the atria nor the ventricles are necessary for the re-entry circuit. Thus, coexistence with AF or AV conduction block is possible but rare.^{66,322} ST-segment depression may be seen during or after the tachycardia.

In the **typical form** of AVNRT (also called slow–fast AVNRT), retrograde P waves are constantly related to the QRS and, in the

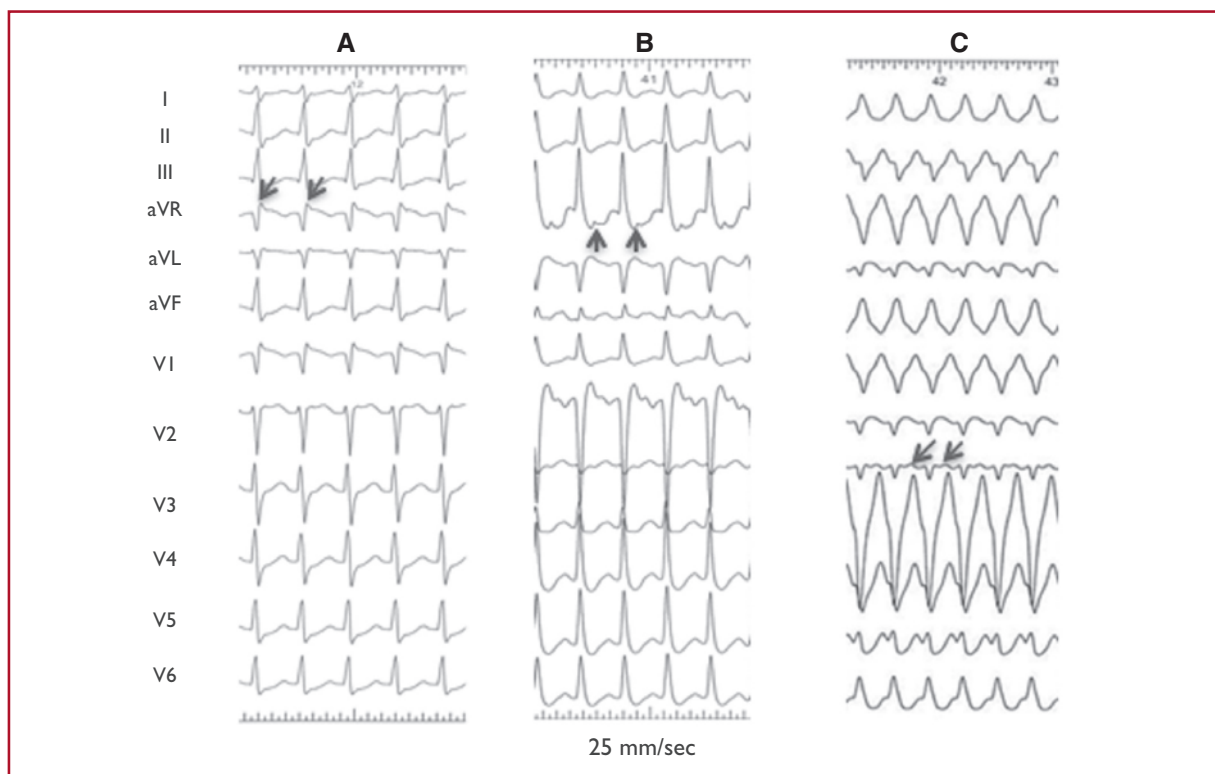

Figure 13 Atrioventricular nodal re-entrant tachycardia. (A) Typical atrioventricular nodal re-entrant tachycardia. (B) Atypical atrioventricular nodal re-entrant tachycardia. (C) Atypical AVNRT with (unusual) left bundle branch block aberration. Retrograde P waves are indicated by arrows.

Table 12 Classification of atrioventricular nodal re-entrant tachycardia types³²⁴

	HA	VA (His)	AH/HA
Typical AVNRT	≤70 ms	≤60 ms	>1
Atypical AVNRT	>70 ms	>60 ms	Variable

© ESC 2019

Atypical atrioventricular nodal re-entrant tachycardia has been traditionally classified as fast–slow (His–atrial >70 ms, ventriculoatrial >60, atrial–His/His–atrial <1, and atrial–His <200 ms) or slow–slow (His–atrial >70 ms, ventriculoatrial interval >60 ms, atrial–His/His–atrial >1, and atrial–His >200 ms). Intermediate, unclassified types may also exist. AH = atrial–His interval; AVNRT = atrioventricular nodal re-entrant tachycardia; HA = His–atrial interval; VA = ventriculoatrial interval measured from the onset of ventricular activation on surface ECG to the earliest deflection of the atrial activation on the His bundle electrogram.

majority of cases, are indiscernible or very close to the QRS complex. Thus, P waves are either masked by the QRS complex or seen as a small terminal P' wave that is not present during sinus rhythm.³²³

In the **atypical form** of AVNRT, P waves are clearly visible before the QRS, i.e. RP>PR, denoting a long RP tachycardia, and are negative or shallow in leads II, III, aVF, and V6, but positive in V1.³¹⁷

Tachycardia-related ST-segment depression, RR-interval variation, as well as QRS alternans may be seen. Specific, although modestly sensitive, ECG criteria for AVNRT, as opposed to AT and AVRT, are a pseudo R deflection in lead V1 and a pseudo S wave in the inferior leads, a notch in lead aVL, and a pseudo R in aVR.⁴⁵ If the tachycardia is initiated by atrial ectopic beats, the initial (ectopic) P wave usually differs from the subsequent (retrograde) P waves.

11.2.1.1.2 Electrophysiology study. Heterogeneity of both fast and slow conduction patterns has been well described, and all forms of AVNRT may display anterior, posterior, and middle, or even LA retrograde, activation patterns.^{322–324} Thus, specific electrophysiological manoeuvres may be required for differential diagnosis of typical and, especially, atypical AVNRT from focal AT or AVRT due to a concealed septal pathway.⁴⁵ The rare form of verapamil-sensitive AT is due to re-entry in the atrial tissue close to the AVN, but not the AV nodal conducting system.³²⁵

11.2.1.1.3 Typical atrioventricular nodal re-entrant tachycardia. In the slow–fast form of AVNRT, the onset of atrial activation appears before, at the onset of, or just after the QRS complex, thus maintaining an AH/His–atrial (HA) ratio >1. The VA interval measured from the onset of ventricular activation on surface ECG to the earliest deflection of the atrial activation in the His bundle electrogram is ≤60 ms. Although, the earliest retrograde atrial activation is typically recorded at the His bundle electrogram, careful mapping studies have demonstrated that posterior or even left septal fast pathways may occur in ≤7.6% in patients with typical AVNRT.^{326–328}

11.2.1.1.4 Atypical atrioventricular nodal re-entrant tachycardia. Atypical AVNRT is seen in ~6% of all AVNRT cases,³¹⁷ and in some

patients may coexist with the typical form.³²⁹ A higher incidence of atypical AVNRT has been documented in athletes.³³⁰ In the so-called 'fast–slow form of AVNRT, retrograde atrial electrograms begin well after ventricular activation with an AH/HA ratio <1, indicating that retrograde conduction is slower than antegrade conduction. The AH interval is <185–200 ms. The VA interval measured from the onset of ventricular activation on surface ECG to the earliest deflection of the atrial activation in the His bundle electrogram is >60 ms. Earliest retrograde atrial activation has generally been reported at the base of the triangle of Koch, near the coronary sinus ostium, but it can be variable, with eccentric atrial activation at the lower septum or even the distal coronary sinus.^{328,331,332} In the 'slow–slow' form, the AH/HA ratio is >1 and the AH interval >200 ms, but the VA interval is >60 ms, suggesting that two slow pathways are utilized for both anterograde and retrograde activation. Earliest retrograde atrial activation is usually at the coronary sinus ostium, but variants of left-sided atrial retrograde activation have also been published.^{333,334} The distinction between 'fast–slow' and 'slow–slow' forms is of no practical significance, and certain cases of atypical AVNRT cannot be classified according to described criteria.³²⁴ There is also evidence that the 'fast' pathway during slow–fast AVNRT is not identical to the 'fast' component of so-called fast–slow AVNRT.³²⁹ Therefore, AVNRT can be classified as typical or atypical according to the HA interval, or—when a His bundle electrogram is not reliably recorded—according to the VA interval measured on the His bundle recording electrode.³²² Table 12 presents a conventional classification system. Other approaches have also been published.³³⁵

11.2.1.2 Therapy

Recommendations for the management of atrioventricular nodal re-entrant tachycardia (AVNRT)

Recommendation	Class ^a	Level ^b
Acute therapy		
Haemodynamically unstable patients		
Synchronized DC cardioversion is recommended for haemodynamically unstable patients. ^{86–88}	I	B
Haemodynamically stable patients		
Vagal manoeuvres, preferably in the supine position with leg elevation, are recommended. ^{41,89–91}	I	B
Adenosine (6–18 mg i.v. bolus) is recommended if vagal manoeuvres fail. ^{92–94}	I	B
Verapamil or diltiazem i.v. should be considered if vagal manoeuvres and adenosine fail. ^{92,94–98}	IIa	B
Beta-blockers (i.v. esmolol or metoprolol) should be considered if vagal manoeuvres and adenosine fail. ^{97,99,100}	IIa	C
Synchronized DC cardioversion is recommended when drug therapy fails to convert or control the tachycardia. ^{87,88}	I	B

Continued

Chronic therapy		
Catheter ablation is recommended for symptomatic, recurrent AVNRT. ^{208,336–339}	I	B
Diltiazem or verapamil, in patients without HFrEF, or beta-blockers should be considered if ablation is not desirable or feasible. ^{340–342}	IIa	B
Abstinence from therapy should be considered for minimally symptomatic patients with very infrequent, short-lived episodes of tachycardia. ³¹⁹	IIa	C

© ESC 2019

i.v. verapamil and diltiazem are contraindicated in the presence of hypotension or HFrEF.

i.v. beta-blockers are contraindicated in the presence of decompensated heart failure.

DC = direct-current; HF = heart failure; HFrEF = heart failure with reduced ejection fraction; i.v. = intravenous.

^aClass of recommendation.

^bLevel of evidence.

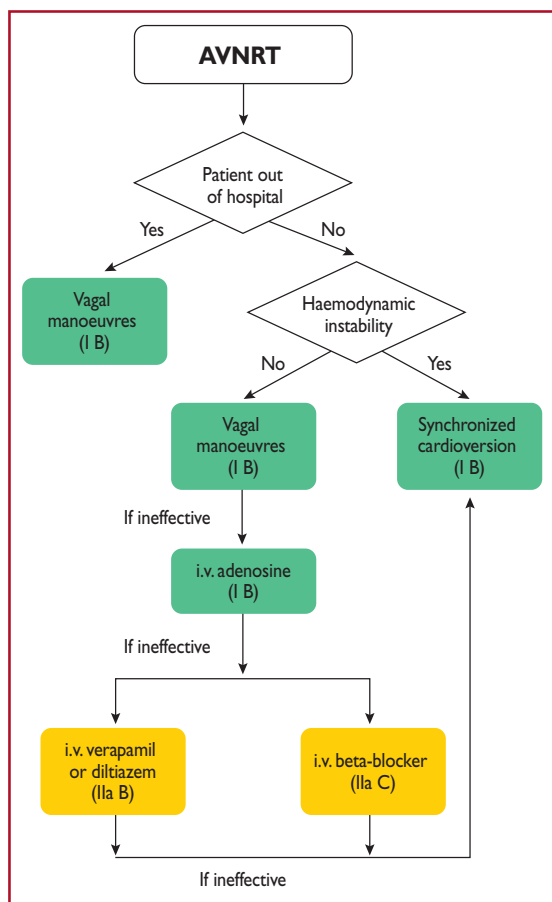

© ESC 2019

Figure 14 Acute therapy of atrioventricular nodal re-entrant tachycardia. AVNRT = atrioventricular nodal re-entrant tachycardia; i.v. = intravenous.

11.2.1.2.1 Acute therapy. Most data on the effectiveness of vagal manoeuvres and adenosine for acute termination of tachycardia are derived from mixed populations of SVT, as described in section 10.1.1 on the acute therapy of SVT in general, but it seems that

they are less successful in AVNRT than in AVRT.^{89,90,102} A single dose of oral diltiazem (120 mg) plus a beta-blocker (i.e. propranolol 80 mg) may convert $\leq 94\%$ of patients, but there is a risk of hypotension, transient AV block, or—rarely—syncope.^{342,344} Caution is needed in the elderly, and in patients with known sinus or AV nodal conduction disturbances. A single dose of oral flecainide (3 mg/kg) may also be effective, albeit at a lower rate.^{342,344} Intranasal etipamil is promising (see section 10.1.1).¹²⁹ Rarely, when vagal manoeuvres and adenosine cannot terminate the tachycardia and hypotension ensues, synchronized DC cardioversion is indicated¹⁰¹ (Figure 14).

11.2.1.2.2 Catheter ablation. A recent randomized clinical trial (RCT) that compared catheter ablation as first-line treatment with antiarrhythmic drugs demonstrated significant benefits in arrhythmia-related hospitalizations.³³⁶ Furthermore, catheter ablation for SVT in general, and AVNRT in particular, is the current treatment of choice for symptomatic patients because it substantially improves quality of life^{28,345,346} and reduces costs.^{347–349} Slow-pathway modification is effective in both typical and atypical AVNRT.³³⁸ Usually, a combined anatomical and mapping approach is employed, with ablation lesions delivered at the inferior part of the triangle of Koch, either from the right or the left septal side.^{337–339,350,351} This approach offers a success rate of 97%, has an $\sim 1.3\text{--}4\%$ recurrence rate, and has been associated with a risk of AV block of $< 1\%$ in previous reports.^{203,204,352,353} Recent experience indicates that in experienced centres, the procedure can be accomplished in both typical and atypical AVNRT with almost no risk of AV block, by targeting the inferior nodal extension and avoiding the mid-septum, and the roof of the coronary sinus.^{208,338,354,355} Success rates are lower (82%) and the risk of heart block higher (14%) in patients with adult congenital heart disease (ACHD).³⁵⁶ Usually, recurrences are seen within 3 months following a successful procedure in symptomatic patients who experience frequent episodes of tachycardia,^{317,329,336,338} but in the young, aged ≤ 18 years, recurrences may be seen as long as 5 years post-ablation.³⁵⁷ IST may occur, but is usually transient and not frequent following slow-pathway ablation.³⁵⁸ Advanced age is not a contraindication for slow-pathway ablation.³⁵⁹ The pre-existence of first-degree heart block carries a higher risk for late AV block and avoidance of extensive slow pathway ablation is preferable under such conditions.³⁶⁰ There is almost no procedure-related mortality.^{11,13,203–205,208} Cryoablation may carry a lower risk of AV block, but is associated with a significantly higher recurrence rate.^{361–363} Its favourable safety profile and higher long-term success rate in younger patients make it especially attractive for the treatment of children.³⁶⁴ AVNRT is a cause of inappropriate shocks in patients with implantable cardioverter defibrillators (ICDs) and, in the case of frequent episodes, catheter ablation is clearly indicated.³⁶⁵

11.2.1.2.3 Chronic therapy. Patients with minimal symptoms and short-lived, infrequent episodes of tachycardia can be followed-up without the need for ablation or long-term pharmacological therapy (Figure 15). Approximately one-half of them may become asymptomatic within the next 13 years.³¹⁹ Chronic administration of antiarrhythmic drugs decreases the frequency and duration of

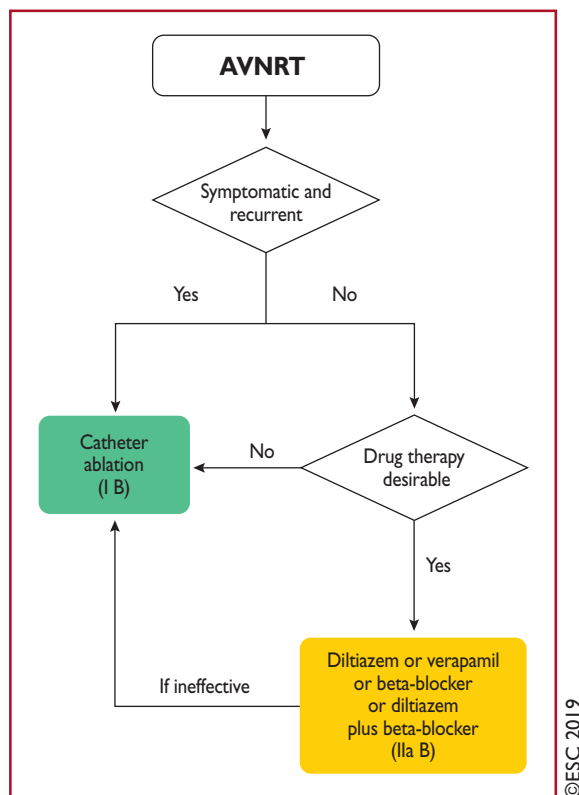

Figure 15 Chronic therapy of atrioventricular nodal re-entrant tachycardia.

AVNRT = atrioventricular nodal re-entrant tachycardia.

AVNRT, but has a variable success rate in abolishing tachycardia episodes, ranging from 13–82%, and $\leq 20\%$ of patients may discontinue therapy.³²³ In view of the excellent success rate and minimal risk of catheter ablation in symptomatic cases, the value of long-term antiarrhythmic drug therapy seems very limited.

11.2.2 Non-re-entrant junctional tachycardias

Junctional ectopic tachycardia (JET), or **focal junctional tachycardia**, is an uncommon arrhythmia that arises from abnormal automaticity at the AVN or proximal His bundle. Focal junctional tachycardia in children may be seen as a congenital arrhythmia or, more often, early after infant open-heart surgery.^{366,367} Congenital junctional tachycardia carries considerable morbidity and mortality.³⁶⁸ Junctional tachycardia can also be seen in adult patients with a structurally normal heart,^{369,370} and has in the past been associated with non-fibrinolyzed acute MI.³⁷¹ The usual ECG finding in JET is a narrow QRS tachycardia with a short RP interval or AV dissociation. Occasionally, the tachycardia might be irregular and resemble AF.

Propranolol (i.v.) with or without procainamide,³⁷⁰ verapamil, or procainamide,³⁷² or flecainide,³⁷³ may be used for acute therapy, but data are scarce. Amiodarone (i.v.) is the drug of choice for post-operative JET as well as for preventing early JET in children after open-heart surgery.^{374,375} In children with congenital junctional tachycardia, amiodarone alone, or with propafenone or ivabradine, appears effective.^{368,376–379} For chronic therapy,

propranolol³⁷⁰ or, in the absence of ischaemic or structural heart disease, flecainide³⁸⁰ and propafenone,³⁸¹ may be tried. Selective catheter ablation at the site of the earliest retrograde atrial activation is feasible, but carries a lower success rate and higher AV block risk compared with AVNRT (5–10%).^{369,382} Cryoablation is safer.^{375,383}

Non-paroxysmal junctional tachycardia was frequently diagnosed in the past as a junctional rhythm of gradual onset and termination, with a rate between 70–130 b.p.m., and was considered a typical example of digitalis-induced DADs and triggered activity in the AVN.³ The RP interval during tachycardia is variable. Myocardial ischaemia, hypokalaemia, chronic obstructive pulmonary disease, and myocarditis are also associated conditions.

Non-re-entrant AV nodal tachycardia caused by **simultaneous multiple nodal pathway conduction** (often called double-fire pathology or dual AV nodal tachycardia) is an uncommon mechanism of AV nodal tachycardia,^{384,385} and has been associated with **repetitive retrograde concealment or 'linking' phenomena**.^{386–388} These are expressed in the form of ventricular pauses with consistent AV relationship after the pause, and can often be misdiagnosed as AF.³⁸⁹ These extremely rare tachycardias may cause TCM and respond to slow-pathway ablation.

11.3 Atrioventricular arrhythmias

AVRTs use an anatomically defined re-entrant circuit that consists of two limbs: first, the AVN–HPS, and second, an AP also called the bypass tract. The two limbs are characterized by differences in refractoriness and conduction times, with critically timed premature atrial or ventricular beats initiating re-entrant tachycardia. On rare occasions, the circuit consists of two APs.

11.3.1 Accessory pathways

APs are single or multiple strands of myocardial cells that bypass the physiological conduction system, and directly connect atrial and ventricular myocardium.³⁹⁰ These AV connections are due to incomplete embryological development of the AV annuli, without complete separation of the atria and ventricles. While there are different types of APs, the most common are those that connect the atrium and the ventricle along the mitral or tricuspid annulus. Approximately 60% are located along the mitral valve and are referred to as left free wall APs, 25% insert along the septal aspect of the mitral or tricuspid annulus, and $\sim 15\%$ insert along the right free wall.^{391–393} Because ventricular muscle is lacking in the proximity of the anterior leaflet of the mitral valve, left-sided APs are usually limited to the region of the mitral annulus at the attachment of the mural (posterior) leaflet. APs located in the superoparaseptal area in close proximity to the His bundle and AVN may also occur.³⁹⁴

APs present characteristic electrophysiological features that differ from AV nodal conduction properties. They typically exhibit fast conduction (with the exception of atypical pathways-see section 11.3.9), dependent on a sodium current similar to that of myocardial cells. Moreover, although a majority of APs conduct both antegradely and retrogradely, some propagate impulses in only one direction. Those that conduct in the antegrade direction only are uncommon ($\leq 10\%$),

whereas those that conduct in the retrograde direction only are more frequent ($\leq 50\%$). When the AP conducts antegradely, ventricular pre-excitation is usually evident at rest during sinus rhythm and the AP is referred to as 'manifest'. Conversely, APs are referred to as 'concealed' if they exclusively conduct retrogradely. Concealed APs may have decremental properties.³⁹⁵ The term 'latent AP' denotes an AP that is not, or is barely, visible due to location or faster conduction through the AVN.

Multiple APs occur in $\leq 12\%$ of patients with pre-excitation, and in $\leq 50\%$ in patients with Ebstein's anomaly.³⁹⁶

AVRT is the most common tachycardia associated with APs. Two mechanisms of re-entry are possible according to the antegrade or retrograde conduction over the AVN–HPS, and are classified as orthodromic and antidromic AVRT.

11.3.2 Wolff–Parkinson–White syndrome

WPW syndrome refers to the presence of an overt (manifest) AP, thus resulting in the so-called pre-excitation, in combination with usually recurrent tachyarrhythmias.³⁹⁷ During sinus rhythm, a typical pattern in the resting ECG with the following characteristics is present: (i) a short PR interval (≤ 120 ms); (ii) slurred upstroke (or downstroke) of the QRS complex ('delta wave'); and (iii) a wide

QRS complex (>120 ms). In most cases, APs giving rise to the WPW pattern are seen in structurally normal hearts. Rare, familial forms of pre-excitation associated with LV hypertrophy and multi-system disease [mutations in the protein kinase adenosine monophosphate-activated non-catalytic subunit gamma 2 (PRKAG2) gene, Danon and Fabry disease, and others] have also been described.³⁹⁸

Several surface ECG algorithms have been developed that can be applied for the localization of APs in the presence of overt pre-excitation (Figures 16 and 17).^{399–401} Pre-excitation on the surface ECG can be intermittent and can even disappear permanently (in $\leq 35\%$ of cases) over time. Furthermore, various degrees of pre-excitation are possible depending on the location of the AP as well as on AVN conduction properties.

11.3.3 Orthodromic atrioventricular re-entrant tachycardia

Orthodromic AVRT accounts for $>90\%$ of AVRTs and for 20–30% of all sustained SVTs. The re-entrant impulse conducts from the atrium to the ventricle through the AVN–HPS, which is the anterograde limb of the re-entrant circuit, whereas the AP conducts from the ventricle to the atrium, and serves as the

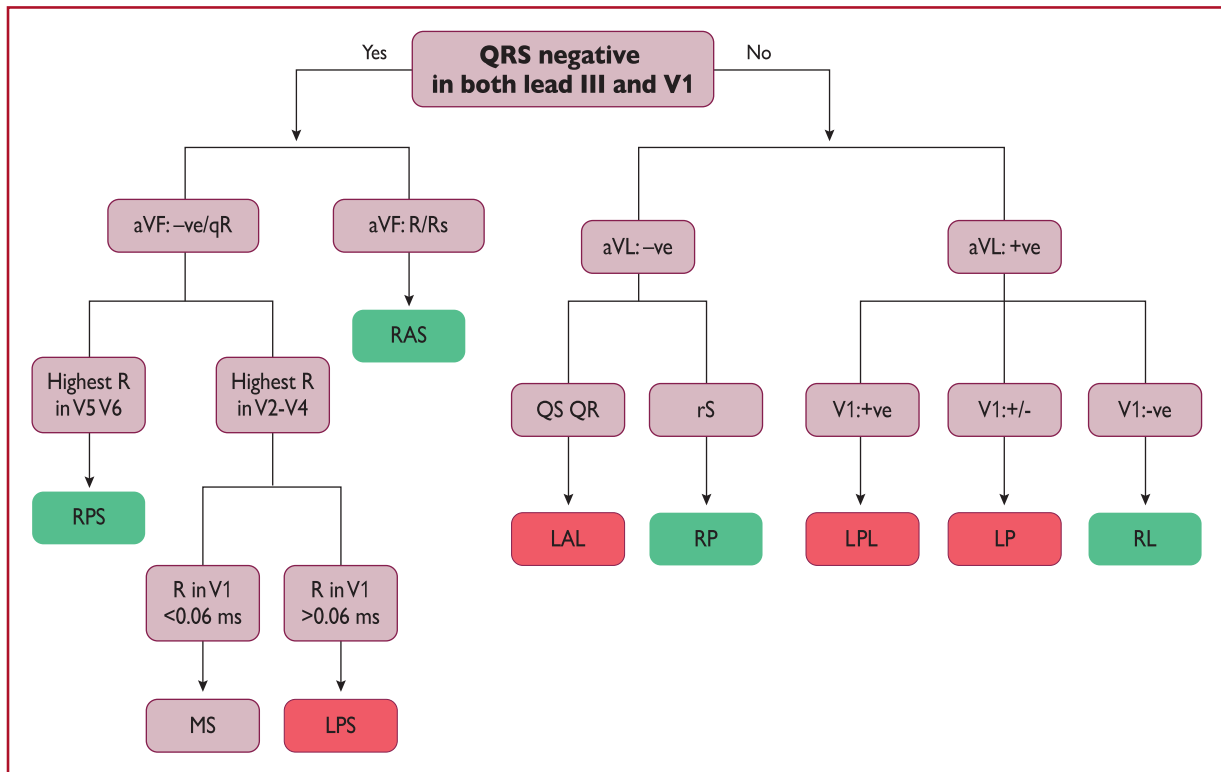

Figure 16 The St George's algorithm for the localization of accessory pathways.³⁹⁹ +ve = QRS complex-positive; -ve = QRS complex-negative; +/- = QRS complex equiphase; AP = accessory pathway; LAL = left anterolateral; LP = left posterior; LPL = left posterolateral; LPS = left posteroseptal; MS = mid-septal; RAS = right anteroseptal; RL = right lateral; RP = right posterior; RPS = right posteroseptal.

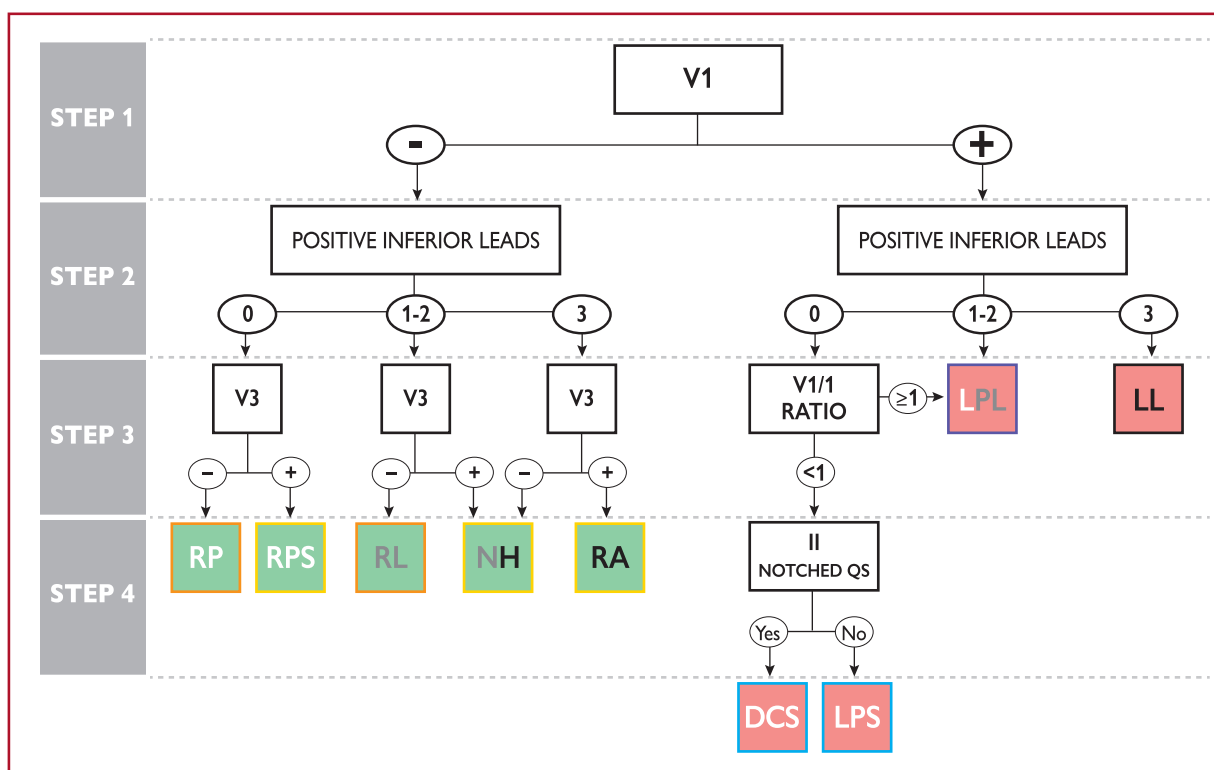

Figure 17 Localization of accessory pathways in the presence of maximum (spontaneous or evoked) pre-excitation.⁴⁰⁰ Accessory pathway locations are green when right-sided and red when left-sided. Left posterolateral accessory pathways can have 0, 1, or 2 inferior leads with positive polarity, whereas nodo-Hisian accessory pathways can have 1, 2, or 3 inferior leads with positive polarity. Right-sided accessory pathways are framed orange or yellow when the V3 lead is negative or positive, respectively. Left posterior accessory pathways are framed blue when the V1/I ratio is < 1 or purple when V1/I ratio is ≥ 1 . AP = accessory pathway; DCS = deep coronary sinus; LL = left lateral; LPL = left posterolateral; LPS = left paraseptal; NH = nodo-Hisian; RA = right anterior; RL = right lateral; RP = right posterior; RPS = right paraseptal.

retrograde limb of the re-entrant circuit. Orthodromic AVRT tends to be a rapid tachycardia, with frequencies ranging from 150 to, rarely, >220 b.p.m. During tachycardia (Figure 18), the following ECG features can be present: (i) RP interval constant and, usually but not invariably, up to one-half of the tachycardia CL; (ii) narrow QRS; (iii) functional BBB usually associated with an AP ipsilateral to the blocked bundle, especially in young patients (aged <40 years); and (iv) ST-segment depression.

11.3.4 Antidromic atrioventricular re-entrant tachycardia

Antidromic AVRT occurs in 3–8% of patients with WPW syndrome.^{402–404} The re-entrant impulse travels from the atrium to the ventricle through the AP with anterograde conduction; meanwhile, retrograde conduction occurs over the AVN or another AP, usually located in a contralateral position to ensure longer travel distances, thus allowing for sufficient recovery of refractoriness of the respective elements of the re-entrant circuit. In 30–60% of patients with spontaneous antidromic AVRT, multiple APs (manifest or concealed), which could act or not as the retrograde limb during the AVRT, may be detected. Antidromic AVRT has the following ECG features, illustrated in Figure 18: (i) a wide QRS complex (fully pre-excited) and (ii) an RP interval that is

difficult to assess as the retrograde P wave is usually inscribed within the ST-T segment.

11.3.5 Accessory pathway as a bystander

In the presence of focal AT, atrial flutter, AF, or AVNRT, the QRS complexes can be pre-excited when the AP acts as a bystander, and is not a critical part of the re-entry circuit.

11.3.6 Pre-excited atrial fibrillation

Paroxysmal AF has been found in 50% of patients with WPW, and may be the presenting arrhythmia in affected patients.^{405,406} These patients are typically young and have no structural heart disease. High-rate AVRT may potentially initiate AF. AF with fast ventricular response over an overt AP with a short anterograde refractory period is a potentially life-threatening arrhythmia in patients with WPW syndrome, due to potential degeneration into VF.

11.3.7 Concealed accessory pathways

Concealed APs give rise only to orthodromic AVRT. Their true prevalence is unknown because they are not detectable on the resting surface ECG, but only at occurrence of AVRT, or during electrophysiology testing.⁴⁵ No sex predilection is found and these pathways

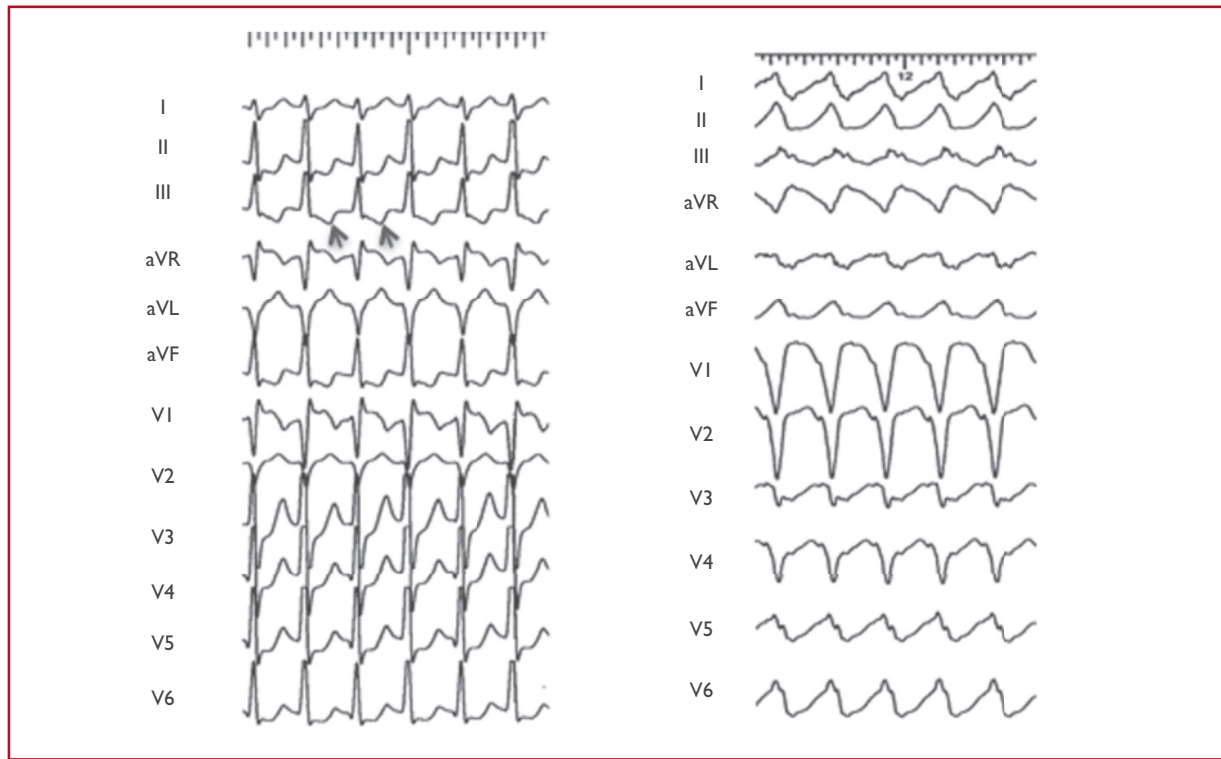

©ESC 2019

Figure 18 Atrioventricular re-entrant tachycardia. Left: orthodromic atrioventricular re-entrant tachycardia due to a concealed posteroseptal accessory pathway. Retrograde P waves are negative during tachycardia in the inferior leads (arrows). Right: Antidromic atrioventricular re-entrant tachycardia due to an atriofascicular accessory pathway. The axis during tachycardia due to atypical pathways depends on the way of insertion into the right bundle and fusion over the left anterior fascicle.

tend to occur more frequently in younger patients than in those with AVNRT; however, significant overlap exists.³ Concealed APs are predominantly localized along the left free wall (64%), and less frequently at septal (31%) and right free wall locations.³⁹⁵ Clinical presentation is with AVRT. Concealed pathways are not associated with an increased risk of sudden cardiac death. The management of AVRT due to a concealed AP is similar to that of an overt AP, but in this case is related to symptoms without significant prognostic relevance in most cases.

11.3.8 Permanent junctional reciprocating tachycardia

PJRT is a rare form of AV reciprocating tachycardia using a concealed AP. Usually these APs, originally described by Coumel, are located in the posteroseptal region and are associated with retrograde decremental conduction properties.⁴⁰⁷ PJRT is a long RP tachycardia due to the slow conduction properties of the AP, and is characterized by deeply inverted retrograde P waves in leads II, III, and aVF due to the retrograde nature of atrial activation. The incessant nature of PJRT may result in TCM that usually resolves after successful treatment by radiofrequency catheter ablation, particularly in younger patients.^{407,408} Catheter ablation is strongly recommended in symptomatic patients or in cases with impaired LV ejection fraction likely related to TCM.

Other potential causes of long RP tachycardias are sinus tachycardia, AT, atypical AVRT, and JET with 1:1 retrograde conduction.

11.3.9 Atypical forms of pre-excitation

Other APs are postulated to result in cardiac pre-excitation. Atypical APs (also called Mahaim fibers) are connections between the right atrium or the AVN and the right ventricle, into or close to the right bundle branch.^{409–414} Most of them are atriofascicular or nodoventricular (as initially described), but they can also be atriofascicular, atrioventricular, nodofascicular, or nodoventricular, depending on their variable proximal and distal insertions.^{413,414} Left-sided atypical pathways have also been described but are extremely rare.^{415–417}

Atypical pathways usually contain accessory nodal tissue, which results in decremental properties, and connect the atrium to the fascicles by crossing the lateral aspect of the tricuspid annulus, but posteroseptal locations can also be found in rare cases. Conduction is usually anterograde only, but concealed fibres have also been described.^{412,418} The following properties define the behaviour of atypical pathways:

- Baseline normal QRS or different degrees of manifest pre-excitation with LBBB morphology;
- Programmed atrial pacing, leading to obvious manifest pre-excitation following an increase in AV interval along with shortening of the HV interval at shorter pacing CLs;

- Antidromic AVRT due to an atriofascicular pathway usually produces a horizontal or superior QRS axis, but a normal axis may also occur, depending on the way of insertion into the right bundle and fusion over the left anterior fascicle.
- Right bundle electrogram preceding His bundle activation during anterograde pre-excitation and SVT.

Mapping identifies the proximal and distal insertion of accessory fibres, and demonstrates pathway potentials in most cases that then guide ablation.^{409,411} Catheter ablation is associated with a high success rate and low recurrence rates, and is therefore recommended for all patients with recurrent symptomatic tachycardia, and especially incessant tachycardias due to concealed nodofascicular or nodoventricular pathways.⁴¹⁸ Preventive ablation for prognostic reasons is not routinely recommended, not even in patients with pre-excitation or BBB in the surface ECG, as fast conduction via the AP is unlikely due to decremental conduction properties.

11.3.10 Therapy

11.3.10.1 Acute therapy

Adenosine should be used with caution for the treatment of AVRT because of potential induction of fast AF.^{119,120,272} AF with fast ventricular

conduction could also induce ventricular fibrillation, therefore electrical cardioversion should always be available. During orthodromic and antidromic AVRT, drug therapy could be directed at one of the components of the circuit, the AVN (beta-blockers, diltiazem, verapamil, or etipamil),^{100,129,419,420} or the AP (ibutilide, procainamide, propafenone, or flecainide)^{421,422} (Figure 19). Antidromic AVRT is associated with malignant WPW syndrome due to a very fast-conducting AP,⁴⁰³ and drugs acting mainly on the AP should be preferred. In addition, in case of antidromic AVRT with APs representing both the anterograde and retrograde limb, drugs acting on the AVN are ineffective. In drug-refractory antidromic AVRT, amiodarone may also be considered.^{423–425}

In patients presenting with pre-excited AF, urgent cardioversion is usually required and the threshold for the use of electrical cardioversion is lower. Conduction of electrical impulses can occur preferentially via the AP due to its shorter RP compared with the AVN.⁴²⁶ Accordingly, any AVN-modulating agents (adenosine, verapamil, diltiazem, beta-blockers, or digoxin) should be avoided in pre-excited AF as they may contribute to a risk of ventricular fibrillation.^{427,428} Pharmacological cardioversion of pre-excited AF or delayed AP conduction can be achieved with ibutilide (Figure 20).⁴²¹ Drugs such as procainamide, propafenone, or flecainide, which affect conduction

Recommendations for the therapy of atrioventricular re-entrant tachycardia due to manifest or concealed accessory pathways

Recommendation	Class ^a	Level ^b
Acute therapy		
Haemodynamically unstable patients		
Synchronized DC cardioversion is recommended for haemodynamically unstable patients. ^{86–88}	I	B
Haemodynamically stable patients		
Vagal manoeuvres, preferably in the supine position with leg elevation, are recommended. ^{41,89–91}	I	B
In orthodromic AVRT, adenosine (6–18 mg i.v. bolus) is recommended if vagal manoeuvres fail and the tachycardia is orthodromic. ^{92–94}	I	B
In orthodromic AVRT, i.v. verapamil or diltiazem should be considered if vagal manoeuvres and adenosine fail. ^{92,94–98}	IIa	B
In orthodromic AVRT, i.v. beta-blockers (esmolol or metoprolol) should be considered in the absence of decompensated HF, if vagal manoeuvres and adenosine fail. ^{97,99,100}	IIa	C
In antidromic AVRT, i.v. ibutilide or procainamide or i.v. flecainide or propafenone or synchronized DC cardioversion should be considered if vagal manoeuvres and adenosine fail. ^{421,422,429,437}	IIa	B
In antidromic AVRT, i.v. amiodarone may be considered in refractory cases. ^{423–425,435}	IIb	B
Synchronized DC cardioversion is recommended when drug therapy fails to convert or control the tachycardia. ^{87,88}	I	B
Chronic therapy		
Catheter ablation of AP(s) is recommended in patients with symptomatic, recurrent AVRT. ^{391–393,438–441}	I	B
Beta-blockers or non-dihydropyridine calcium-channel blockers (verapamil or diltiazem in the absence of HFrEF) should be considered if no signs of pre-excitation are present on resting ECG, if ablation is not desirable or feasible. ^{340,341,442,443}	IIa	B
Propafenone or flecainide may be considered in patients with AVRT and without ischaemic or structural heart disease, if ablation is not desirable or feasible. ^{429,444,445}	IIb	B
Digoxin, beta-blockers, diltiazem, verapamil, and amiodarone are not recommended and are potentially harmful in patients with pre-excited AF. ^{427,428,432–434,446}	III	B

i.v. verapamil and diltiazem are contraindicated in the presence of hypotension or HFrEF.

i.v. beta-blockers are contraindicated in the presence of decompensated heart failure.

i.v. ibutilide is contraindicated in patients with prolonged QTc interval.

i.v. procainamide prolongs the QTc interval but much less than class III agents.

i.v. flecainide and propafenone are contraindicated in patients with ischaemic or structural heart disease. They also prolong the QTc interval but much less than class III agents.

i.v. amiodarone prolongs the QTc but torsades des pointes is rare.

AF = atrial fibrillation; AP = accessory pathway; AVRT = atrioventricular re-entrant tachycardia; DC = direct-current; ECG = electrocardiogram; HFrEF = heart failure with reduced ejection fraction; i.v. = intravenous.

^aClass of recommendation.

^bLevel of evidence.

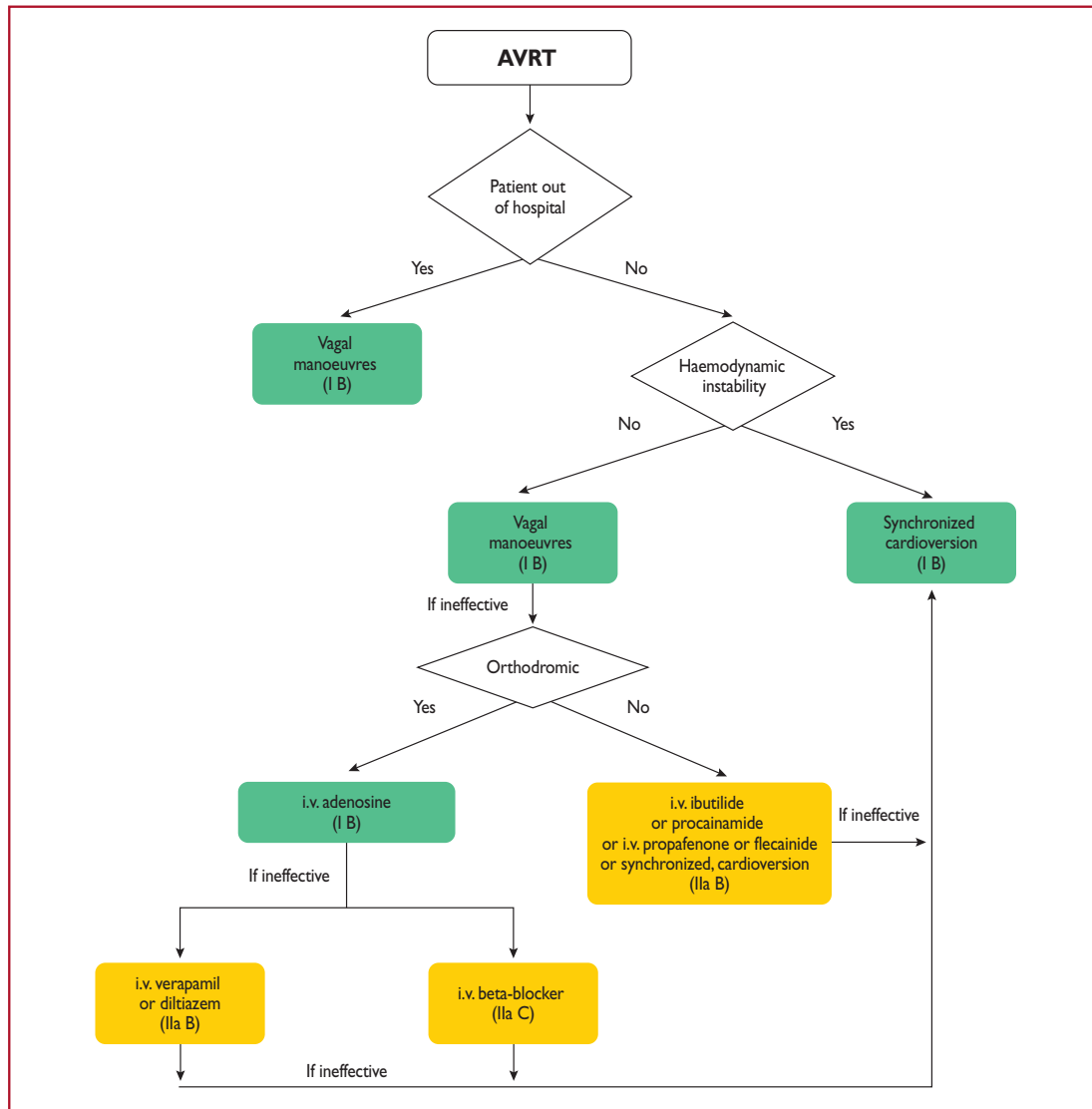

©ESC 2019

Figure 19 Acute therapy of atrioventricular re-entrant tachycardia. AVRT = atrioventricular re-entrant tachycardia; i.v. = intravenous.

Recommendations for the acute therapy of pre-excited atrial fibrillation

Recommendation	Class ^a	Level ^b
Haemodynamically unstable patients		
Synchronized DC cardioversion is recommended in haemodynamically unstable patients. ^{86,130}	I	B
Haemodynamically stable patients		
Ibutilide or procainamide (i.v.) should be considered. ^{421,430,436}	IIa	B
Flecainide or propafenone (i.v.) may be considered. ^{429,431}	IIb	B
Synchronized DC cardioversion is recommended if drug therapy fails to convert or control the tachycardia. ^{86,130}	I	B
Amiodarone (i.v.) is not recommended. ^{432–435}	III	B

i.v. ibutilide is contraindicated in patients with prolonged QTc interval.
 i.v. procainamide prolongs the QTc interval but much less than class III agents.
 i.v. flecainide and propafenone are contraindicated in patients with ischaemic or structural heart disease. They also prolong the QTc interval but much less than class III agents.
 DC = direct current.
^aClass of recommendation.
^bLevel of evidence.

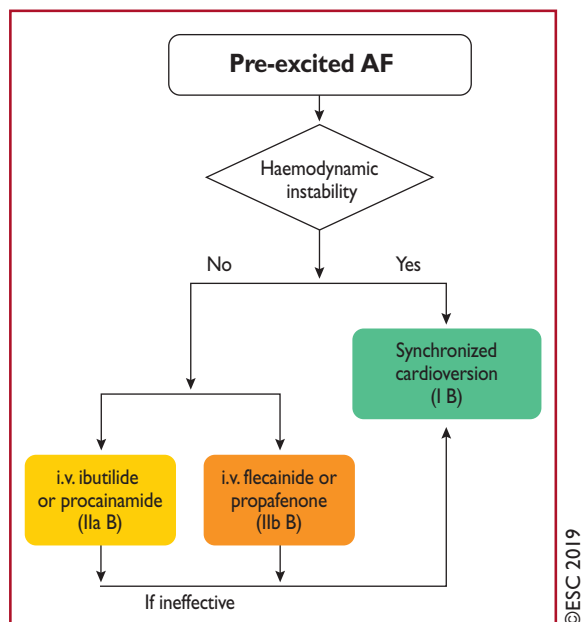

Figure 20 Acute therapy of pre-excited atrial fibrillation. AF = atrial fibrillation; i.v. = intravenous.

over the AP, may also be used, even if they may not restore sinus rhythm.^{429–431} However, class Ic drugs should be used with caution as they do exert an effect on the AVN. In pre-excited AF, i.v. amiodarone may not be as safe as previously thought, because enhanced pathway conduction and ventricular fibrillation have been reported, and should not be considered.^{432–435} Procainamide appears to be safer in this setting.⁴³⁶

11.3.10.2 Catheter ablation

The treatment of choice for patients with symptomatic and recurrent AVRT, or pre-excited AF, is catheter ablation (Figure 21). For other patients with asymptomatic and infrequent episodes, therapeutic decisions should be balanced between the overall risks and benefits of the invasive nature of ablation vs. long-term commitment to pharmacological therapy. Ablation of the AP has a high acute success rate and is associated with a low complication rate depending on the pathway location (Table 9).^{391–393,438–440} Major complications include cardiac tamponade (0.13–1.1%) and complete AV block (0.17–2.7%) in patients in whom ablation of septal APs is attempted. With septal APs close to the AVN, the ECG typically displays a positive delta wave in leads aVf and aVl, and a narrow positive delta wave in lead V1 that has a prominently negative QRS complex.³⁹⁴

When targeting septal pathways and applying cryoenergy, the incidence of AV block is lower compared with radiofrequency energy.⁴⁴⁷ However, recurrence of previously blocked pathways has been reported to be significantly higher when cryoenergy is applied.⁴³⁸ Two approaches are available for left-sided pathways: an antegrade transseptal and a retrograde aortic approach. There is evidence that the transseptal approach, in experienced hands, results in reduced radiation and procedure times.^{441,448}

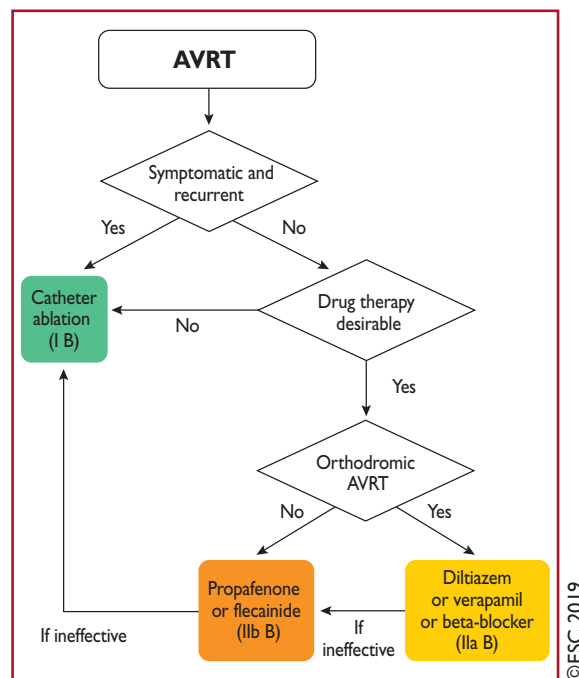

Figure 21 Chronic therapy of atrioventricular re-entrant tachycardia. AVRT = atrioventricular re-entrant tachycardia.

The 2015 American College of Cardiology/American Heart Association/Heart Rhythm Society Guideline for the Management of Adult Patients With Supraventricular Tachycardia reported major complication rates after radiofrequency catheter ablation of 3.0 and 2.8% for AVNRT and AVRT, respectively.² These rates are much higher than those reported by experienced electrophysiologists in the current era, as summarized in Table 9, but the procedure still carries a very small, non-negligible, mortality risk.^{203,205}

11.3.10.3 Chronic therapy

If ablation is not desirable or feasible in patients with pre-excitation and symptomatic antidromic AVRT, and in whom structural or ischaemic heart disease has been excluded, class IC antiarrhythmic drugs act mainly on the AP and can be used in antidromic tachycardia (Figure 21).^{429,437,444,445} In cases of pre-excited AF, caution should be taken not to transform it into atrial flutter and induce 1:1 conduction. Apart from class IC drugs, beta-blockers, diltiazem, or verapamil may also be considered in case of orthodromic tachycardias if no signs of pre-excitation are observed on the resting ECG.^{340,341,442,443}

11.3.11 The asymptomatic patient with pre-excitation

Most patients with an asymptomatic WPW pattern will go through life without any clinical events related to their ventricular pre-excitation. Approximately one in five patients will develop an arrhythmia related to their AP during follow-up. The most common arrhythmia in patients with WPW syndrome is AVRT (80%), followed by a 20–30% incidence of AF. Sudden cardiac death

secondary to pre-excited AF that conducts rapidly to the ventricle over the AP, resulting in ventricular fibrillation, is the most feared manifestation of WPW syndrome. The risk of cardiac arrest/ventricular fibrillation has been estimated at 2.4 per 1000 person-years (95% confidence interval 1.3–3.9), but no deaths were reported in a registry of 2169 patients over an 8 year follow-up period.⁴³⁹ However, in a Danish registry of 310 individuals with pre-excitation (age range 8–85 years), there was a greater risk of AF and HF, driven by a right anteroseptal AP, and in patients aged >65 years there was also a statistically significant higher risk of death.²²

Clinical and electrophysiological features associated with an increased risk of sudden cardiac death include younger age,^{439,449,450} inducibility of AV-reciprocating tachycardia during EPS,^{450–454} multiple APs,^{450,451,455,456} and demonstration of a capability of the AP to allow rapid conduction to the ventricles.^{439,450,451,453–456} These variables include the shortest pre-excited RR interval during AF (SPERRI) of ≤250 ms at baseline or a short antegrade effective refractory period (ERP) of the AP (≤250 ms).^{439,450–452,454–460} With non-invasive testing, identification of an abrupt and complete normalization of the PR interval with loss of delta wave during exercise testing, or following procainamide, propafenone, or disopyramide administration, has been considered a marker of low risk.^{459,461–463} Catecholamine sensitivity is a major limiting factor of all tests, both invasive^{452,460} and non-invasive, including exercise testing.^{459,461,462} Intermittent loss of pre-excitation on a resting ECG or ambulatory monitoring has also been associated with APs with longer ERPs, and has been accepted as a credible risk-stratification tool.^{2,464} However, a number of recent studies, which have included both symptomatic and asymptomatic patients, have indicated that more than one-fifth of patients with intermittent pre-excitation have AP ERPs <250 ms. Thus, intermittent pre-excitation is now recognized as an imperfect marker of a low-risk AP.^{406,462,465–469}

Over the past 30 years, a considerable body of literature has been published that has focused on the important topic of the evaluation and management of patients with asymptomatic pre-excitation. These publications include those that describe the clinical and electrophysiological characteristics of patients with pre-excitation who have experienced a cardiac arrest,^{439,451,455,459} and series of patients with pre-excitation who are either symptomatic or asymptomatic, and are followed for variable periods of time.^{22,405,439,449,450,454,456,470–472} Among these studies, there has been one prospective RCT of catheter ablation (37 patients) vs. clinical follow-up without treatment (35 patients) of patients with asymptomatic pre-excitation.⁴⁵³ Catheter ablation reduced the frequency of arrhythmic events (7 vs. 77%, *P* < 0.001) over 5 years. One patient in the control group had an episode of cardioverted ventricular fibrillation.

Figure 22 summarizes the recommendations for the screening and management of patients with asymptomatic pre-excitation.

Recommendations for the management of patients with asymptomatic pre-excitation

Recommendation	Class ^a	Level ^b
Performance of an EPS, with the use of isoprenaline, is recommended to risk stratify individuals with asymptomatic pre-excitation who have high-risk occupations/hobbies, ^c and those who participate in competitive athletics. ^{439,450–452,454–460}	I	B
Catheter ablation is recommended in asymptomatic patients in whom electrophysiology testing with the use of isoprenaline identifies high-risk properties, such as SPERRI ≤250 ms, AP ERP ≤250 ms, multiple APs, and an inducible AP-mediated tachycardia. ^{439,450,452,454–460}	I	B
Catheter ablation is recommended in high-risk patients with asymptomatic pre-excitation after discussing the risks, especially of heart block associated with ablation of anteroseptal or MS APs, and benefits of the procedure. ^{439,440,473–476}	I	C
Performance of an EPS to risk stratify individuals with asymptomatic pre-excitation should be considered. ^{439,450–452,454–460}	IIa	B
Non-invasive evaluation of the conducting properties of the AP in individuals with asymptomatic pre-excitation may be considered. ^{459,461–463,465–469}	IIb	B
Invasive risk stratification with an EPS is recommended in patients without 'low-risk' characteristics at non-invasive risk stratification. ^{462,463,465–469,477}	I	C
Clinical follow-up should be considered in a patient with asymptomatic pre-excitation and a low-risk AP at invasive risk stratification. ^{450,452,456,463,477}	IIa	C
Catheter ablation may be considered in a patient with asymptomatic pre-excitation, and a low-risk AP at invasive or non-invasive risk stratification. ^{405,450,452,456,463,477}	IIb	C
Catheter ablation should be considered in patients with asymptomatic pre-excitation and LV dysfunction due to electrical dyssynchrony. ^{478–481}	IIa	C
Catheter ablation may be considered in patients with low-risk asymptomatic pre-excitation in appropriately experienced centres according to patient preferences. ^{203,439,450,453,454,471,474,482}	IIb	C

AP = accessory pathway; EPS = electrophysiology study; ERP = effective refractory period; LV = left ventricular; MS = mid-septal; SPERRI = shortest pre-excited RR interval during atrial fibrillation.

^aClass of recommendation.

^bLevel of evidence

^cSuch as pilots and professional drivers.

Invasive screening with an EPS should be performed in patients with asymptomatic pre-excitation who either have high-risk occupations or are competitive athletes (Figure 22). Variables on the EPS that identify patients with a high-risk AP include a SPERRI ≤ 250 ms, AP ERP ≤ 250 ms, multiple APs, and an inducible AP-mediated tachycardia in the baseline state or during isoproterenol infusion, which should always be tried.^{452,460} The options for screening patients who do not fall into these groups include the use of EPS as a risk-stratifying

tool or the use of non-invasive screening with exercise testing, drug testing, and ambulatory monitoring as risk-stratification tools.

If a patient undergoes screening with an EPS and is found to have an AP with 'high-risk' characteristics, catheter ablation should be performed. Catheter ablation of an AP, when performed by an experienced operator, is associated with a high cure rate ($>95\%$) and low risk ($<0.5\%$) of major complications (see also Section 11.1.2.3).^{438–440} However, it should be noted that even invasive

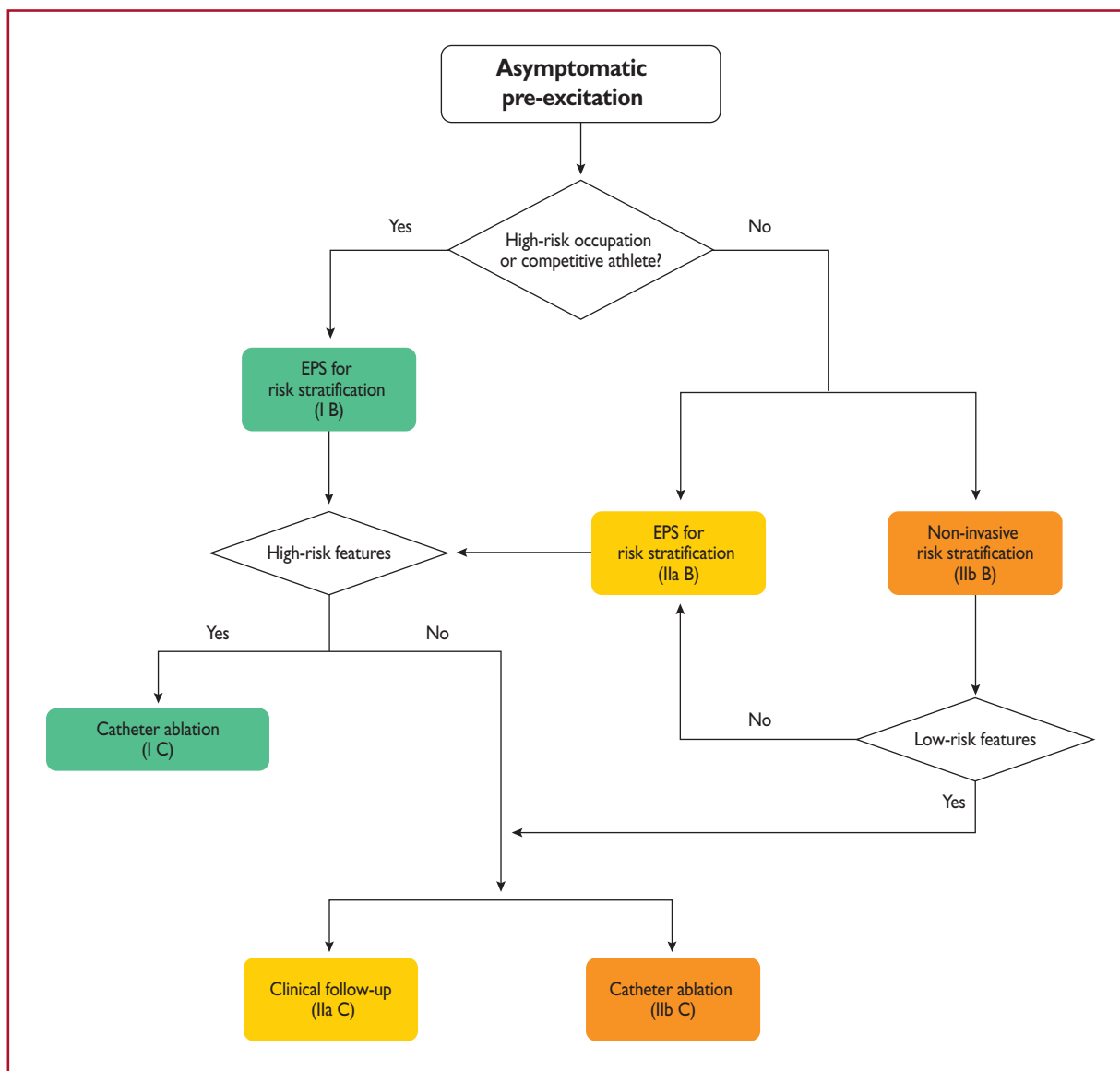

Figure 22 Risk stratification and therapy of patients with asymptomatic pre-excitation. High-risk features at electrophysiology study are shortest pre-excited RR interval during atrial fibrillation ≤ 250 ms, accessory pathway effective refractory period ≤ 250 ms, multiple accessory pathways, and inducible atrioventricular re-entrant tachycardia. Low-risk features at non-invasive risk stratification are induced or intermittent loss of pre-excitation on exercise or drug testing, resting electrocardiogram, and ambulatory electrocardiogram monitoring. EPS = electrophysiology study.

studies do not confer absolute certainty about risk assessment. In a recent retrospective study in 912 young patients (aged ≤ 21 years) with WPW syndrome, 96 experienced life-threatening events,⁴⁰⁵ of whom 49% had rapidly conducted pre-excited AF. In patients with events subjected to EPS risk stratification, 22 of 60 (37%) did not have EPS-determined high-risk characteristics, and 15 of 60 (25%) had neither concerning pathway characteristics nor inducible AVRT. There has also been evidence supporting the notion of LV dysfunction related to electrical asynchrony in patients, especially children, with asymptomatic pre-excitation.^{478–481} It seems reasonable to recommend EPS and consider ablation if a link between pre-excitation and LV dysfunction can be made.

Catheter ablation of an asymptomatic 'low-risk' AP also appears reasonable in appropriately experienced centres according to informed patient choice. However, when a decision is made to perform catheter ablation, it is important to recognise that ablation of APs in the anteroseptal or mid-septal (MS) region is associated with a small risk of AV block. The risk of heart block associated with ablation of anteroseptal or MS APs may preclude ablation of an anteroseptal or MS AP in an asymptomatic patient.

Thus, the approach for patients with asymptomatic pre-excitation that does not exhibit high-risk characteristics at EPS depends on the experience and expertise of the electrophysiologist performing the procedure, as well as the preferences and values of the patient. In the CASPED registry involving 182 children and adolescents with asymptomatic pre-excitation, catheter ablation achieved a 91% success rate without significant complications.⁴⁸²

12 Supraventricular tachycardia in adults with congenital heart disease

The number of adults with congenital heart disease is increasing at a rate of $\sim 60\%$ per decade in developed countries.^{483,484} Currently, it is estimated that ~ 1 million adults with congenital heart disease live in the European Union. Despite ongoing advances in paediatric surgery and cardiology, allowing $>90\%$ of children born with congenital heart disease to survive to adulthood,⁴⁸⁵ these patients usually continue to be afflicted by late complications leading to increased morbidity and mortality. Alongside HF, cardiac arrhythmias are a common late complication in adults with congenital heart defects.⁴⁸⁶ This is due to the underlying cardiac defect, previous or persisting haemodynamic issues, and previous surgical interventions resulting in myocardial damage and scarring.⁴⁸⁷ Arrhythmic burden ranges from bradycardia arrhythmias to SVTs, and life-threatening VTs or fibrillation.

Owing to preceding operations and underlying anatomy, patients with tetralogy of Fallot, Ebstein's anomaly, transposition of the great arteries after atrial switch procedure, and complex patients with uni-ventricular hearts and Fontan palliation are especially prone to late development of arrhythmias, such as incisional or intra-atrial re-entry

tachycardia, and ventricular tachycardia.⁴⁸⁸ However, even patients with usually non-complex lesions such as atrial septal defects have an increased life risk of atrial arrhythmias.

In addition to being related to symptoms, SVTs have been reported as risk factors for sudden cardiac death in patients with ACHD. This issue particularly affects patients with obstructive lesions of the systemic ventricle, tetralogy of Fallot, after Fontan operation, and a systemic right ventricle.^{489,490} Unfortunately, diagnosis and treatment of arrhythmias in ACHD patients is complicated by the unusual nature of tachycardia, complex intracardiac anatomy, and especially by difficulties in accessing the heart, for example due to abnormal venous anatomy (e.g. azygos continuity or previous Fontan operation). As a consequence, specific expertise in patients with ACHD and access to adequate electrophysiological tools are required when performing catheter ablation procedures in these patients.

12.1 Pharmacological antiarrhythmic therapy

Acute therapy of SVT in the context of ACHD is as described for narrow QRS SVT, in general.^{491,492} Randomized controlled trials of chronic antiarrhythmic therapy in patients with complex ACHD are lacking. All antiarrhythmic drugs carry a proarrhythmic risk, and many patients with ACHD have underlying sinus node dysfunction or a predisposition for AVN disease. Antiarrhythmic drugs should therefore be used with particular caution, and are generally reserved for symptomatic patients after options for catheter ablation procedures and haemodynamic optimization (e.g. correction of underlying valvular problems) have been exhausted. Beta-blockers may be used to slow AV nodal conduction and may be considered, with caution, in patients with transposition of the great arteries after the atrial switch operation. This is supported by studies reporting a reduction in ventricular fibrillation and/or appropriate ICD shocks in patients treated with beta-blocking drugs.^{493,494} However, care is needed as these patients may suffer from chronotropic incompetence and cannot tolerate beta-blockade.⁴⁹⁵ Owing to recognized pro-arrhythmic effects, class IC drugs should be used with appropriate caution in the ACHD setting. Similar considerations refer to quinidine, disopyramide, and sotalol. In the recent report of the DARE study cohort, amiodarone, flecainide, and sotalol were clearly found to be pro-arrhythmic, especially in the presence of a prolonged QT, in older women, and in patients with underlying cardiovascular comorbidity, family history of sudden death, and hypokalaemia.⁴⁹⁶ Flecainide is highly effective in infants with SVT, but there are concerns about its toxicity at older ages.^{496,497} Most centres have a lower threshold for the use of amiodarone in patients with ACHD as it is perceived to be less pro-arrhythmic. However, it is commonly associated with thyroid disorders and less commonly with other well-described potentially life-changing complications. These considerations should severely limit its long-term use in patients with ACHD, thus further supporting the first-line use of ablation attempts wherever possible.⁴⁹⁸

Recommendations for the therapy of supraventricular tachycardia in congenital heart disease in adults

Recommendation	Class ^a	Level ^b
Anticoagulation for focal AT or atrial flutter should be similar to that for patients with AF. ^{241,242,499}	I	C
Acute therapy		
Haemodynamically unstable patients		
Synchronized DC cardioversion is recommended for haemodynamically unstable patients. ^{86–88,491,492}	I	B
Haemodynamically stable patients		
Vagal manoeuvres, preferably in the supine position with leg elevation, are recommended. ^{41,89–91}	I	B
Adenosine (6–18 mg i.v. bolus) is recommended if vagal manoeuvres fail. ^{92–94}	I	B
i.v. verapamil or diltiazem should be considered, if vagal manoeuvres and adenosine fail. ^{92,94–98}	IIa	B
i.v. beta-blockers (esmolol or metoprolol) should be considered if vagal manoeuvres and adenosine fail. ^{97,99,100}	IIa	C
Synchronized DC cardioversion is recommended when drug therapy fails to convert or control the tachycardia. ^{87,88}	I	B
Chronic therapy		
Catheter ablation in experienced centres should be considered. ^{292,500,501}	IIa	C
Beta-blockers should be considered for recurrent focal AT or atrial flutter, if ablation is not possible or successful. ²³⁷	IIa	C
In patients with SVT planned for surgical repair of a congenital heart disease anomaly, pre-operative catheter ablation or intraoperative surgical ablation should be considered. ^{502–504}	IIa	C
Amiodarone may be considered for prevention if ablation is not possible or successful. ⁵⁰⁵	IIb	C
Sotalol is not recommended as a first-line antiarrhythmic drug as it is related to an increased risk of pro-arrhythmias and mortality. ⁴⁹⁶	III	C
Flecainide and propafenone are not recommended as first-line antiarrhythmic drugs in patients with ventricular dysfunction and severe fibrosis. ⁴⁹⁷	III	C

i.v. verapamil and diltiazem are contraindicated in the presence of hypotension or HFrEF.

i.v. beta-blockers are contraindicated in the presence of decompensated heart failure.

AF = atrial fibrillation; AT = atrial tachycardia; DC = direct-current; HF = heart failure; HFrEF = heart failure with reduced ejection fraction; i.v. = intravenous; SVT = supraventricular tachycardia.

^aClass of recommendation.

^bLevel of evidence

12.2 Catheter and surgical ablation

Owing to underlying anatomy and previous operations, interventional access for ablation procedures may be challenging in patients with ACHD. In addition, the nature of SVT is often atypical, and related to multiple re-entrant circuits and fibrotic atrial tissue. As a consequence, special expertise and experience with ablation of complex tachyarrhythmias and scar-related procedures are necessary.⁵⁰⁶ It is recommended that patients with complex incisional tachycardias are referred to specialist centres with adequate experience, volumes of ablation procedures, and advanced mapping capabilities. Catheter ablation procedures in the setting of ACHD are associated with lower success rates compared with the general cohort of patients with AF or atrial flutter.⁴⁸⁴ However, ablation of CTI-related arrhythmias has been reported to have a high acute success rate (>95%), although the mid-term recurrence rate may approach 20%.⁵⁰⁷ Pre-operative catheter ablation or concomitant arrhythmia surgery should be considered in patients with ACHD undergoing cardiac surgery, as its incorporation can result in improved functional class and potentially decreased requirements for chronic antiarrhythmic medication in this vulnerable population.^{502–504}

12.3 Specific disease states

12.3.1 Atrial septal defect

The incidence of atrial arrhythmias in patients with atrial septal defects ranges between 5–15%.⁵⁰⁸ The exact impact of atrial septal defect closure, especially of late closure, on the risk of developing AT is controversial. Patients commonly present with RA MRAT. The leading

mechanism is CTI-dependent tachycardia and this is generally susceptible to catheter ablation. However, CTI-dependent and 'incisional' atrial flutter may coexist. Closure of an existing atrial septal defect, in isolation, is generally insufficient to abolish an existing AT and catheter ablation should be considered before defect closure. Mid-term recurrence rates of 40–44% have been reported in atrial septal defect patients post-flutter or AF ablation^{508,509}; however, this should not preclude ablation procedures wherever possible.

12.3.2 Ebstein's anomaly

ATs are common in Ebstein's anomaly, occurring in 25–65% of patients.^{501,510–512} The types of arrhythmia include atrial flutter, focal AT, and AF. In addition, 10–45% of patients have right-sided APs, including WPW syndrome. More than one AP is common in this setting, and can in itself increase the risk of haemodynamic compromise and sudden cardiac death. Catheter ablation of APs has a high success rate; however, ablation procedures may be challenging and repeat procedures may be necessary as some patients have multiple ablation targets. In addition, patients may develop different arrhythmia mechanisms following ablation.⁵⁰¹ In patients undergoing surgical repair, routine pre-operative EPS can be recommended as the diagnostic and therapeutic yield in this population is high.⁵¹³

12.3.3 Transposition of the great arteries (dextro-transposition of the great arteries) after atrial switch operation (Mustard or Senning)

Owing to previous surgery and scarring, atrial re-entrant tachycardias are common in patients with a Mustard or Senning repair. In addition,

sinus node dysfunction may occur as a consequence of the atrial redirection procedure.⁴⁹⁵ As tachycardia is not well tolerated in patients with asystemic right ventricular and diastolic dysfunction, maintaining long-term sinus rhythm is highly desirable in this setting. Use of antiarrhythmic drugs is limited due to ventricular and sinus node dysfunction, and pro-arrhythmic risk. Ablation procedures in patients with a Mustard or Senning repair have a high acute success rate; however, recurrence rates approach 30% during long-term follow-up.^{500,514–516}

12.3.4 Tetralogy of Fallot

SVTs are not uncommon in patients with tetralogy of Fallot. In addition to being related to symptoms, the occurrence of supraventricular arrhythmias has been linked to a statistically higher risk of sudden cardiac death in this population.⁵¹⁷ As catheter ablation has a high procedural success rate, it should be considered as a first-line option in this setting.⁵¹⁸ In addition, patients with new-onset atrial arrhythmias should be thoroughly evaluated to exclude addressable haemodynamic lesions such as severe pulmonary valve regurgitation, which may be amenable to surgical or interventional therapy leading indirectly to reduced arrhythmia burden.

12.3.5 Fontan repairs

AT is common in patients post-Fontan palliation. Patients with a classic (atriopulmonary) Fontan procedure are at especially high risk for AT, with $\leq 60\%$ developing SVTs after 15 years of follow-up.⁵¹⁹ In addition to symptoms and the risk of cardiac thromboembolism, AT is poorly tolerated haemodynamically in patients with univentricular hearts, and may lead to acute deterioration and overt HF in this setting.⁵²⁰ Catheter ablation is often effective but challenging, due to the nature of the arrhythmia circuits as well as issues with cardiac access.^{514,515} Various surgical modifications, such as the conversion to total cavopulmonary connection, have evolved and can ameliorate the risk of atrial arrhythmias.⁵²¹

13 Supraventricular tachycardia in the paediatric population

Specific detailed recommendations for paediatric patients are published elsewhere^{522,523} and are beyond the scope of this document. In general, certain aspects are different in the paediatric population and should be taken into account.

Immaturity of the cardiac structures, including conduction tissue, may lead to modifications in the electrophysiology of the heart. Therefore, some APs present in the first months of life (even those associated with tachycardias) may disappear before the first year of age.⁵²² Actually, AVRT due to WPW that begins in infancy may resolve in $\sim 90\%$ of patients, but may recur in later childhood in 30–50% of patients; however, if the tachycardia is present after the age of 5, it persists in $>75\%$ of patients.⁵²⁴

It is clear that small children may not complain of symptoms, so indirect signs have to be assessed when SVT is suspected, i.e. irritability, failure to thrive, and even flat growing curves. It is not uncommon to discover an incessant SVT in a patient presenting with cardiogenic shock due to TCM. This most frequently occurs in relatively slow SVTs, such as PJRT and focal AT.^{525,526}

Pharmacokinetics and pharmacodynamics in children are different to those in adults; therefore, special attention has to be given when prescribing drugs.⁵²⁷ This is particularly important in newborns as

milk can substantially modify the absorption of the drug and, as feeding schedules tend to be erratic, can affect effective drug availability. Furthermore, many drugs have to be prepared at specialized pharmacies, adding to the risk of incorrect dosing, and drug solutions may also need to be stored under special conditions to maintain their stability. This can be inconvenient when long-term treatment is required as, for example, a portable cooler bag must be carried. In addition, the long-term effects of some drugs, as they accumulate, are especially dangerous in growing bodies. This is of special interest regarding amiodarone, which can chronically provoke the same secondary effects as it does in adults. Verapamil has to be avoided whenever possible or given very carefully to small patients as it can provoke severe hypotension.⁵²² A decreased response of adenosine in younger children has also been suggested.⁵²⁸

Invasive techniques are possible and effective even in very small children, when indicated, but there are several limiting factors. First, radiofrequency lesion formation in immature sheep myocardium is similar to that in adult sheep myocardium acutely, but is associated with late lesion enlargement and fibrous tissue invasion of normal myocardium. These observations may have implications for clinical radiofrequency ablation procedures in infants⁵²⁹ and avoidance of radiofrequency ablation, if at all possible, in the first 2 years of life is prudent. Second, no specific catheters and tools exist for the paediatric population. Currently, available catheters (minimum 5 French for non-irrigated radiofrequency tips) and curves are, in general, too large. This is particularly limiting in small children needing an ablation to resolve incessant tachycardia. Finally, the experience of the operator and the centre is crucial. Small patients requiring ablation should be referred to experienced reference centres for treatment. The number of catheters used, and procedural and radiation times, should be minimized in these growing bodies.⁵³⁰ Electroanatomical mapping systems are most valuable in this setting.

13.1 Foetal arrhythmias

Foetal arrhythmias can be detected at an early gestational age, with incessant, rapid SVTs associated with foetal death due to hydrops. Therefore, a special effort has to be made to detect and control foetal arrhythmias. A strong correlation between post-natal SVT and later gestational age at foetal SVT diagnosis has been reported.⁵³¹ Diagnosis relies on echocardiography as foetal ECGs are not available in most clinics (it is used in just a few centres worldwide and primarily for research purposes).⁵³² When sustained foetal tachycardia is observed, treatment is mandated. There are several protocols for this purpose, and they are mostly based on digoxin, flecainide, and sotalol alone or in combination depending on the type of tachycardia. These drugs have to be given to the mother, with a fraction reaching the foetus. This means that the secondary effects of these drugs can manifest in both the foetus and mother. Close follow-up is therefore needed.^{522,533,534}

14 Supraventricular tachycardia in pregnancy

Sustained SVT becomes more frequent during pregnancy, occurring in 22–24/100 000 pregnancies. It may even manifest for the first time, particularly in the third trimester or peri-partum, according to comprehensive discharge data from hospitals.⁵³⁵ The overall

frequency of any arrhythmia is greater in women aged 41–50 years (199/100 000) than in those aged 18–30 years (55/100 000), which may be due to more prevalent AF and VT, whereas SVT seems stable over time.⁵³⁵ Arrhythmias are also more frequent among women with congenital heart disease, particularly atrial flutter, compared with women without congenital defects.⁵³⁶

As substantive prospective or randomized studies are unavailable, recommendations are primarily based on small cohorts or case reports in conjunction with expert opinion.

14.1 Maternal, obstetric, and offspring risk

SVT is associated with an increased risk of death during pregnancy, and the reported frequency is 68 per 100 000 pregnancy-related hospitalizations for any arrhythmia, 22 per 100 000 for SVT, 4 per 100 000 for atrial flutter, 27 per 100 000 for AF, 2 per 100 000 for ventricular fibrillation, and 16 per 100 000 for VT.⁵³⁵

Identification and treatment of underlying conditions are the first priorities. Although most of the exacerbations of SVT during pregnancy are benign and can be treated effectively with standard medical therapy,⁵³⁷ the circumstances that should be considered include the well-being of the foetus and the effects on labour, delivery, and lactation. The haemodynamic effect of tachycardia, as well as side effects of treatments, must be balanced and addressed for the foetus. Catheter ablation should therefore be considered before pregnancy when possible in patients with a known history of symptomatic tachyarrhythmia. Trials evaluating the level of surveillance at delivery are needed.

14.2 Therapy

14.2.1 Antiarrhythmic drugs

Treatment with antiarrhythmic drugs for the prevention of SVT should, in general, be reserved for SVTs causing haemodynamic compromise or significant symptoms. The major concern regarding the use of antiarrhythmic drugs during pregnancy is potential adverse effects on the foetus. While the first trimester is associated with the greatest teratogenic risk, drug exposure later in pregnancy may result in adverse effects on foetal growth and development, and on uterine contractility, and an increased risk of pro-arrhythmia. The risks and benefits of continuing vs. stopping medication must be carefully considered in terms of the risk of recurring SVT, and the potential for haemodynamic compromise. Decisions should be individualized, based on the clinical situation and possible additional structural heart disease. Major controlled studies of antiarrhythmic drugs during pregnancy are lacking. If non-invasive manoeuvres fail, adenosine should be the first-line drug for treatment if needed during the second and third trimesters. There is a paucity of data on management of SVT in the first trimester.⁵⁴² All beta-blockers can cause bradycardia and hypoglycaemia in the foetus. As beta-1 selective beta-blockers are less likely to affect uterine relaxation, they are preferred.⁵⁴⁶ Maternal use of beta-blockers in the first trimester has not been associated with a large increase in the risk for overall or cardiac malformations.^{548,553} However, in the EUROmediCAT study, an association between alpha/beta-adrenergic blocker use in the first trimester with multicystic renal dysplasia was reported.⁵⁵⁴ There have been concerns about 'low weight for gestational age' with beta-blockers, although the effects reported may not be large enough to be of clinical importance. Exposure to atenolol has been associated with a

Recommendations for the therapy of supraventricular tachycardia in pregnancy

Recommendation	Class ^a	Level ^b
Catheter ablation is recommended in symptomatic women with recurrent SVT who plan to become pregnant. ⁵³⁸	I	C
Acute therapy		
Immediate electrical cardioversion is recommended for any tachycardia with haemodynamic instability. ^{539,540}	I	C
Vagal manoeuvres and, if these fail, adenosine are recommended for acute conversion of SVT. ^{541,542}	I	C
An i.v. beta-1 selective blocker (except atenolol) should be considered for acute conversion or rate control of SVT. ^{542,543}	IIa	C
i.v. digoxin in the latest pocket GIs version should be considered for rate control of AT if beta-blockers fail. ^{542,543}	IIa	C
i.v. ibutilide in the latest pocket GIs version may be considered for termination of atrial flutter. ^{544,545}	IIb	C
Chronic therapy		
During the first trimester of pregnancy, it is recommended that all antiarrhythmic drugs should be avoided, if possible.	I	C
Beta-1 selective (except atenolol) beta-blockers or verapamil, in order of preference, should be considered for prevention of SVT in patients without WPW syndrome. ^{543,546–548}	IIa	C
Flecainide or propafenone should be considered for prevention of SVT in patients with WPW syndrome, and without ischaemic or structural heart disease. ⁵⁴⁹	IIa	C
Flecainide or propafenone in patients without ischaemic or structural heart disease should be considered if AV nodal blocking agents fail to prevent SVT. ^{533,543}	IIa	C
Digoxin or verapamil should be considered for rate control of AT if beta-blockers fail in patients without WPW syndrome. ⁵⁴³	IIa	C
Amiodarone is not recommended in pregnant women. ^{153,543}	III	C
Fluoroles catheter ablation should be considered in cases of drug-refractory or poorly tolerated SVT, in experienced centres. ^{550–552}	IIa	C

i.v. ibutilide is contraindicated in patients with prolonged QTc interval.

AT = atrial tachycardia; AV = atrioventricular; i.v. = intravenous; SVT = supraventricular tachycardia; WPW = Wolff–Parkinson–White.

^aClass of recommendation.

^bLevel of evidence

higher risk of infants born small for their gestational age compared with metoprolol and propranolol, consistent with this association not being a class effect.^{543,555} Diltiazem has been found to be teratogenic in animals, with only limited human data, and its use is not generally recommended in pregnancy. Verapamil is considered safer than diltiazem and could be used as a second-line drug.^{153,543}

14.2.2 Electrical cardioversion

Electrical cardioversion should be the first choice when arrhythmias are haemodynamically unstable. Cardioversion seems safe in all phases of pregnancy as it does not compromise foetal blood flow, and has low risk of inducing foetal arrhythmias or initiating pre-term labour.⁵³⁹ The foetal heart rate should be routinely controlled after cardioversion.

14.2.3 Catheter ablation

Catheter ablation should be postponed to the second trimester if possible, but may be necessary in the case of drug-refractory and poorly tolerated tachycardia. It should then be performed at an experienced centre using non-fluoroscopic electroanatomical mapping and catheter navigation systems.⁵⁵⁶ Catheter ablation of recurrent, drug-refractory AVNRT, AVRT, focal AT, and CTI-dependent atrial flutter has been successful during pregnancy.^{550–552}

15 Tachycardia-induced cardiomyopathy

15.1 Definition

Tachycardia-induced cardiomyopathy (TCM), or more accurately arrhythmia-induced cardiomyopathy, is a reversible cause of impaired LV function due to persistent tachycardia or very frequent ventricular premature beats that can lead to HF and death. The incidence of TCM is unknown but has been reported in all age groups, from foetuses to the elderly.

15.2 Mechanism

The syndrome was initially described with PJRT, but we now know that any chronic cardiac arrhythmia may cause TCM. Incessant AVRTs due to septal APs, rapid AF, idiopathic VT, AT, and persistent ectopic beats are best described.^{196,233,526,557–563} In patients aged <18 years, focal AT is the commonest cause.⁴⁰⁸

Rapid pacing in animal models induces cytoskeletal changes and remodelling of the extracellular matrix attributed to abnormal calcium cycling, increased catecholamines, decreased beta-1 adrenergic receptor density, oxidative stress, depletion of myocardial energy stores, and myocardial ischaemia due to increased heart rate.^{559,564} Endomyocardial biopsy specimens from patients with TCM exhibit features distinct from those of other types of cardiomyopathy, including deranged cardiomyocyte and mitochondrial morphology, and macrophage-dominated cardiac inflammation.⁵⁶⁵ However, it has not been fully established how the majority of patients with frequent premature ventricular contractions have a benign course, whereas $\leq 30\%$ of them may develop cardiomyopathy.⁵⁶⁶

15.3 Diagnosis

TCM is one of the very few reversible causes of HF and dilated cardiomyopathy, and should be considered in any patient with new onset of LV dysfunction. In the presence of persistent or frequent tachycardia, or frequent premature ventricular contractions, a high index of suspicion should be maintained. The diagnosis is established by excluding other causes of cardiomyopathy, and demonstrating recovery of LV function after eradication of the arrhythmia or control of the ventricular rate. Typically in TCM, LV ejection fraction is $<30\%$, LV end-diastolic diameter is <65 mm, and LV end-systolic diameter is <50 mm.⁵⁵⁷ More dilated ventricular volumes suggest underlying dilated cardiomyopathy, although some overlapping of the two conditions can occur. In patients with suspected TCM, cardiac magnetic resonance (CMR) is advisable to exclude intrinsic structural change. Serial assessment of N-terminal pro-B-type natriuretic peptide (NT-proBNP) and estimation of the ratio of NT-proBNP at baseline to NT-proBNP during follow-up can help differentiate TCM from irreversible idiopathic dilated cardiomyopathy.

15.4 Therapy

Recommendations for the therapy of supraventricular tachycardia in patients with suspected or established heart failure due to tachycardiomyopathy

Recommendation	Class ^a	Level ^b
Catheter ablation is recommended for TCM due to SVT. ^{196,233,418,525}	I	B
Beta-blockers (from the list with proved mortality and morbidity benefits in HFrEF) are recommended for TCM due to SVT, when catheter ablation fails or is not applicable. ⁵⁶⁷	I	A
It is recommended that TCM is considered in a patient with reduced LV ejection fraction with an elevated heart rate (>100 b.p.m.). ^{557–561}	I	B
24 h (or multiday) ambulatory ECG monitoring should be considered for diagnosis of TCM by identifying subclinical or intermittent arrhythmias. ^{526,557,568}	IIa	B
AV nodal ablation with subsequent pacing ('ablate and pace'), either biventricular or His-bundle pacing, is recommended if the tachycardia responsible for the TCM cannot be ablated or controlled by drugs. ^{526,557,564,569–572}	I	C

b.p.m. = beats per minute; ECG = electrocardiogram; HFrEF = heart failure with reduced ejection fraction; LV = left ventricular; SVT = supraventricular tachycardia; TCM = tachycardiomyopathy.

^aClass of recommendation.

^bLevel of evidence.

In TCM, LV function frequently improves after ~ 3 months of restoration of a normal heart rate. In IST, beta-blockers are indicated. Catheter ablation is indicated when TCM is due to another SVT. When the tachycardia itself cannot be ablated, AV nodal ablation

with either biventricular or His-bundle pacing is appropriate.^{569–572} Long-term medical therapy with beta-blockers, and angiotensin-converting enzyme inhibitors or angiotensin II receptor blockers, is indicated before and after successful ablation for the known beneficial effects of these drugs on the LV remodelling process. Given the risk of recurrence of arrhythmias, long-term monitoring of patients is recommended.

16 Supraventricular tachycardia in sports

Athletes with frequent supraventricular arrhythmias should be assessed to exclude the presence of an underlying cardiac disease, electrolyte imbalance, thyroid dysfunction, and the use of stimulants or performance-enhancing drugs. *Table 13* outlines the recommendations for sports eligibility of patients with SVT.^{573,574}

Ventricular pre-excitation (WPW syndrome) is a rare cause of sudden cardiac death in young athletes.⁵⁷⁵ Although many individuals with ventricular pre-excitation remain asymptomatic throughout their lives, symptomatic AVRT may occur. Patients with WPW may also develop other arrhythmias, such as AF, which could degenerate into ventricular fibrillation and sudden cardiac death. Because sports activity has been associated with an increased risk of AF,⁵⁷⁶ athletes with ventricular pre-excitation have an increased risk of sudden cardiac death if the AP has the potential for fast antegrade conduction. Thus, catheter ablation of the AP is currently recommended in symptomatic athletes with ventricular pre-excitation. Asymptomatic athletes with intermittent pre-excitation (at rest or during exercise) or abrupt disappearance of pre-excitation during stress testing may be considered to be at low risk (see section 11.3.11 for reservations), but should be further evaluated as they may be eligible for competitive sports activity. In asymptomatic athletes with ventricular pre-excitation, invasive risk stratification should be conducted as described in section 11.3.11 and catheter ablation should be

performed in those with high-risk features.⁵⁷⁷ Asymptomatic patients stratified at low risk are allowed to practice competitive sports.

AVNRT, orthodromic AVRT over a concealed AP, and AT are not listed among the causes of sudden cardiac death during exercise in patients with a structurally normal heart. However, their occurrence during sports activity may be associated with very high heart rate because of sympathetic stimulation and may cause haemodynamic impairment even in patients with structurally normal hearts. Accordingly, catheter ablation should generally be recommended for all athletes with a history of paroxysmal SVT. Athletes with SVT who do not wish to undergo catheter ablation, or in whom the procedure has been unsuccessful, may be considered eligible for competitive sports activity if the arrhythmia is sporadic, unrelated to cardiac disease, well tolerated, and unrelated to exercise, and when the sports activity does not have a high intrinsic risk of loss of consciousness (such as divers, pilots, horse riders, etc.).⁵⁷⁸

Treatment of paroxysmal SVT with beta-blockers or sodium channel blockers is discouraged in athletes, because these drugs may reduce performance during sports and have limited ability to prevent arrhythmia recurrence during sports activity. Moreover, beta-blockers are listed by the World Anti-Doping Agency as prohibited drugs in particular sports.

17 Supraventricular tachycardia and driving restrictions

The frequency of which medical causes contribute to motor vehicle accidents is not precisely known. Data on arrhythmias as a cause of motor vehicle accidents are hard to obtain due to the difficulty of documenting such events in the general population. However, the proportion is believed to be small, with ~1–3% of all motor vehicle accidents established as being due to a driver's sudden incapacitation.⁵⁷⁹ Of these accidents, 5–10% are related to cardiac causes, with

Table 13 Recommendations for sports participation in athletes with ventricular pre-excitation and supraventricular arrhythmias

	Criteria for eligibility	Eligibility
Premature atrial beats	No symptoms, no cardiac disease	All sports
AVRT or AF in the context of WPW syndrome	Ablation is mandatory. Sports are allowed 1 month after ablation if there are no recurrences	All sports
Asymptomatic ventricular pre-excitation	Ablation is mandatory in patients at high risk. Sports are allowed 1 month after ablation if there are no recurrences	All sports
Paroxysmal SVT (AVNRT, AVRT over a concealed AP, and AT)	Ablation is recommended. Sports are allowed 1 month after ablation if there are no recurrences	All sports
	Ablation undesirable or not feasible	All sports, except those with high intrinsic risk of loss of consciousness

AF = atrial fibrillation; AP = accessory pathway; AT = atrial tachycardia; AVNRT = atrioventricular nodal re-entrant tachycardia; AVRT = atrioventricular re-entrant tachycardia; SVT = supraventricular tachycardia; WPW = Wolff–Parkinson–White

Table 14 European Working Group 2013 report on driving and cardiovascular disease: driving in arrhythmias and conduction disorders: supraventricular tachycardia

Conduction disorder/arrhythmia	Group 1	Group 2
AF/atrial flutter/focal AT	Driving may continue provided no history of syncope. If history of syncope, driving must cease until the condition has been satisfactorily controlled/treated.	Driving may continue provided no history of syncope and anticoagulation guidelines are adhered to. If history of syncope, driving must cease unless the underlying cause is treated and the risk of recurrence is low. Rate control during tachycardia should be adequate. Driving can only be resumed after medical assessment.
AVNRT, AVRT, and WPW	If history of syncope, driving must cease until the condition has been satisfactorily controlled/treated.	Driving may continue provided no history of syncope or other significant symptoms (e.g. palpitations with dizziness). If so, driving must cease until the underlying cause is treated so that the risk of recurrence is low. In case of pre-excitation, driving may only be allowed after specialist assessment.

AF = atrial fibrillation; AT = atrial tachycardia; AVNRT = atrioventricular nodal re-entrant tachycardia; AVRT = atrioventricular re-entrant tachycardia; WPW = Wolff-Parkinson-White.

or without syncope, while <2% of cases of reported sudden driver incapacitation have resulted in injury or death to bystanders, or other road users.⁵⁷⁹

In 2013, a Working Group of the ESC published detailed recommendations on driving restriction in patients with SVT (Table 14).⁵⁸⁰ Two groups of drivers are considered. Group 1 comprises drivers of motorcycles, cars, and other small vehicles with and without a trailer. Group 2 includes drivers of vehicles over 3500 kg or passenger-carrying vehicles exceeding eight seats excluding the driver. Drivers of taxicabs, small ambulances, and other vehicles form an intermediate category between the ordinary private driver and the vocational driver.

18 Key messages

- Not all SVTs are arrhythmias of the young.
- Vagal manoeuvres and adenosine are the treatments of choice for the acute therapy of SVT, and may also provide important diagnostic information.
- Verapamil is not recommended in wide QRS-complex tachycardia of unknown aetiology.
- Consider using ivabradine, when indicated, together with a beta-blocker.
- In all re-entrant and most focal arrhythmias, catheter ablation should be offered as an initial choice to patients, after having explained in detail the potential risks and benefits.
- Patients with macro-re-entrant tachycardias following atrial surgery should be referred to specialized centres for ablation.
- In post-AF ablation ATs, focal or macro-re-entrant, ablation should be deferred for ≥ 3 months after AF ablation, when possible.
- Ablate AVNRT, typical or atypical, with lesions in the anatomical area of the nodal extensions, either from the right or left septum.

- AVNRT, typical or atypical, can now be ablated with almost no risk of AV block.
- Do not use sotalol in patients with SVT.
- Do not use flecainide or propafenone in patients with LBBB, or ischaemic or structural heart disease.
- Do not use amiodarone in pre-excited AF.
- One in five patients with asymptomatic pre-excitation will develop an arrhythmia related to their AP during follow-up.
- The risk of cardiac arrest/ventricular fibrillation in a patient with asymptomatic pre-excitation is ~ 2.4 per 1000 person-years.
- Non-invasive screening may be used for risk stratification of patients with asymptomatic pre-excitation, but its predictive ability remains modest.
- Invasive assessment with an EPS is recommended in patients with asymptomatic pre-excitation who either have high-risk occupations or are competitive athletes.
- If a patient undergoes assessment with an EPS and is found to have an AP with 'high-risk' characteristics, catheter ablation should be performed.
- If possible, avoid all antiarrhythmic drugs during the first trimester of pregnancy. If beta-blockers are necessary, use only beta-1 selective agents (but not atenolol).
- If ablation is necessary during pregnancy, use non-fluoroscopic mapping.
- Consider TCM in patients with reduced LV function and SVT.
- Ablation is the treatment of choice for TCM due to SVT. AV nodal ablation with subsequent biventricular or His-bundle pacing ('ablate and pace') should be considered if the SVT cannot be ablated.

19 Gaps in the evidence

- The distinction between triggered activity and enhanced automaticity is not straightforward, as the two mechanisms share many similar responses and characteristics, such as enhancement by

adrenergic activation and suppressed by L-type Ca^{2+} current blockade.

- Re-entrant circuits may be microscopic or simulate foci by surface 'breakthrough' of transmural propagation. Thus, mapping may be inadequate to distinguish them from automatic/triggered activity.
- The exact circuit of AVNRT, the most common regular arrhythmia in the human, remains unresolved.
- The potential role of connexin proteins in AVNRT, and SVT in general, is under investigation.
- Both invasive and non-invasive tests for the risk assessment of patients with asymptomatic pre-excitation have limitations, being dependent on the autonomic tone. More accurate risk-stratification models are needed.

- The proper management of asymptomatic pre-excitation and strict catheter ablation indications have not been established.
- The genetics of SVT have not been adequately studied. There has been evidence for familial forms of AVNRT, AVRT, sinus tachycardia, and AT, but data are scarce.
- Novel electroanatomical mapping systems now allow the simultaneous visualization of activation and voltage. The implications that this may have on characterizing the tachycardia substrate, and not just the circuit, require future research.
- Mathematical modelling and numerical analysis of recorded ECGs, using fast Fourier and Gaussian models, may be helpful for the future of artificial intelligence applications in the differential diagnosis of narrow and wide QRS-complex tachycardias, but experience is limited.

20 'What to do' and 'what not to do' messages from the Guidelines

'What to do' messages

Recommendations for the acute management of narrow QRS tachycardia in the absence of an established diagnosis

Recommendation	Class ^a	Level ^b
Haemodynamically unstable patients		
Synchronized direct-current cardioversion is recommended for haemodynamically unstable patients.	I	B
Haemodynamically stable patients		
A 12-lead ECG during tachycardia is recommended.	I	C
Vagal manoeuvres, preferably in the supine position with leg elevation, are recommended.	I	B
Adenosine (6–18 mg i.v. bolus) is recommended if vagal manoeuvres fail.	I	B
Synchronized direct-current cardioversion is recommended when drug therapy fails to convert or control the tachycardia.	I	B

Recommendations for the acute management of wide QRS tachycardia in the absence of an established diagnosis

Haemodynamically unstable patients		
Synchronized direct-current cardioversion is recommended in haemodynamically unstable patients.	I	B
Haemodynamically stable patients		
A 12-lead ECG during tachycardia is recommended.	I	C
Vagal manoeuvres, preferably in the supine position with leg elevation, are recommended.	I	C
Synchronized direct-current cardioversion is recommended if drug therapy fails to convert or control the tachycardia.	I	B

Recommendations for the therapy of sinus tachycardias

Inappropriate sinus tachycardia		
Evaluation and treatment of reversible causes is recommended. ^{139,144,162}	I	C

Recommendations for the therapy of focal AT

Acute therapy		
Haemodynamically unstable patients		
Synchronized DC cardioversion is recommended for haemodynamically unstable patients.	I	B
Haemodynamically stable patients		
Synchronized DC cardioversion is recommended when drug therapy fails to convert or control the tachycardia.	I	B
Chronic therapy		
Catheter ablation is recommended for recurrent focal AT, especially if incessant or causing tachycardiomyopathy.	I	B

Recommendations for the therapy of multifocal AT

Acute therapy		
Treatment of an underlying condition is recommended as a first step, if feasible.	I	C

Continued

Recommendations for the therapy of multifocal AT

Anticoagulation as in AF is recommended for patients with atrial flutter and concomitant AF.	I	B
--	---	---

Acute therapy**Haemodynamically unstable patients**

Synchronized DC cardioversion is recommended for haemodynamically unstable patients.	I	B
--	---	---

Haemodynamically stable patients

Intravenous ibutilide or i.v. or oral (in-hospital) dofetilide is recommended for conversion to sinus rhythm in the absence of QTc interval prolongation.	I	B
---	---	---

Low-energy (≤ 100 J biphasic) electrical cardioversion is recommended for conversion to sinus rhythm.	I	B
---	---	---

High-rate atrial pacing is recommended for termination of atrial flutter in the presence of an implanted pacemaker or defibrillator.	I	B
--	---	---

Long-term therapy

Catheter ablation is recommended for symptomatic, recurrent episodes of cavotricuspid isthmus-dependent flutter.	I	A
--	---	---

Catheter ablation in experienced centres is recommended for symptomatic, recurrent episodes of non-CTI-dependent flutter.	I	B
---	---	---

Catheter ablation is recommended in patients with persistent atrial flutter or in the presence of depressed LV systolic function due to tachycardiomyopathy.	I	B
--	---	---

Recommendations for the management of AVNRT**Acute therapy****Haemodynamically unstable patients**

Synchronized DC cardioversion is recommended for haemodynamically unstable patients. ⁸⁶⁻⁸⁸	I	B
---	---	---

Haemodynamically stable patients

Vagal manoeuvres, preferably in the supine position with leg elevation, are recommended. ^{41, 89-91}	I	B
---	---	---

Adenosine (6–18 mg i.v. bolus) is recommended if vagal manoeuvres fail. ⁹²⁻⁹⁴	I	B
--	---	---

Synchronized DC cardioversion is recommended when drug therapy fails to convert or control the tachycardia. ^{87, 88}	I	B
---	---	---

Long-term therapy

Catheter ablation is recommended for symptomatic, recurrent AVNRT. ^{208, 336-339}	I	B
--	---	---

Recommendations for the therapy of AVRT due to manifest or concealed APs**Acute therapy****Haemodynamically unstable patients**

Synchronized DC cardioversion is recommended for haemodynamically unstable patients.	I	B
--	---	---

Haemodynamically stable patients

Vagal manoeuvres, preferably in the supine position with leg elevation, are recommended.	I	B
--	---	---

Adenosine (6–18 mg i.v. bolus) is recommended if vagal manoeuvres fail and the tachycardia is orthodromic.	I	B
--	---	---

Synchronized DC cardioversion is recommended when drug therapy fails to convert or control the tachycardia.	I	B
---	---	---

Chronic therapy

Catheter ablation of AP(s) is recommended in patients with symptomatic, recurrent AVRT.	I	B
---	---	---

Recommendations for the acute therapy of pre-excited AF**Haemodynamically unstable patients**

Synchronized DC cardioversion is recommended in haemodynamically unstable patients.	I	B
---	---	---

Haemodynamically stable patients

Synchronized DC cardioversion is recommended if drug therapy fails to convert or control the tachycardia.	I	B
---	---	---

Recommendations for the management of patients with asymptomatic pre-excitation

Performance of an EPS, with the use of isoprenaline, is recommended to risk stratify individuals with asymptomatic pre-excitation who have high risk occupations/hobbies, ^c and those who participate in competitive athletics.	I	B
--	---	---

Catheter ablation is recommended in asymptomatic patients in whom electrophysiology testing with the use of isoprenaline identifies high-risk properties, such as SPERRI ≤ 250 ms, AP ERP ≤ 250 ms, multiple APs, and an inducible AP-mediated tachycardia.	I	B
---	---	---

Catheter ablation is recommended in high-risk patients with asymptomatic pre-excitation after discussing the risks, especially of heart block associated with ablation of anteroseptal or mid-septal APs, and benefits of the procedure.	I	C
--	---	---

Invasive risk stratification with an EPS is recommended in patients without “low risk” characteristics at non-invasive risk stratification.	I	C
---	---	---

Continued

Recommendations for the therapy of SVTs in congenital heart disease in adults

Anticoagulation for focal AT or atrial flutter should be similar to patients with AF.	I	C
Acute therapy		
Haemodynamically unstable patients		
Synchronized DC cardioversion is recommended for haemodynamically unstable patients.	I	B
Haemodynamically stable patients		
Vagal manoeuvres, preferably in the supine position with leg elevation, are recommended.	I	B
Adenosine (6–18 mg i.v. bolus) is recommended if vagal manoeuvres fail.	I	B
Synchronized DC cardioversion is recommended when drug therapy fails to convert or control the tachycardia.	I	B

Recommendations for the therapy SVT in pregnancy

Catheter ablation is recommended in symptomatic women with recurrent SVT who plan to become pregnant.	I	C
Acute therapy		
Immediate electrical cardioversion is recommended for any tachycardia with haemodynamic instability.	I	C
Vagal manoeuvres and, if these fail, adenosine are recommended for acute conversion of SVT.	I	C
Chronic therapy		
During the first trimester of pregnancy it is recommended to avoid all antiarrhythmic drugs, if possible.	I	C

Recommendations for the therapy of SVT in patients with suspected or established heart failure due to tachycardiomyopathy

Recommendation	Class ^a	Level ^b
Catheter ablation is recommended for tachycardiomyopathy due to SVT.	I	B
Beta-blockers (from the list with proven mortality and morbidity benefits in HFrEF) are recommended for tachycardiomyopathy due to SVT, when catheter ablation fails or is not applicable.	I	A
It is recommended to consider tachycardiomyopathy in patient with reduced LV ejection fraction with an elevated heart rate (>100 bpm).	I	B
AV nodal ablation with subsequent pacing (“ablate and pace”), either biventricular or His-bundle pacing, is recommended if the tachycardia responsible for the tachycardiomyopathy cannot be ablated or controlled by drugs.	I	C

‘What not to do’ messages**Recommendations for the acute management of wide QRS tachycardia in the absence of an established diagnosis**

Verapamil is not recommended in wide QRS-complex tachycardia of unknown aetiology.	III	B
--	-----	---

Recommendations for the therapy of MRATs**Acute therapy**

Propafenone and flecainide are not recommended for conversion to sinus rhythm.	III	B
--	-----	---

Recommendations for the therapy of AVRT due to manifest or concealed APs**Chronic therapy**

Digoxin, beta-blockers, diltiazem, verapamil, and amiodarone are not recommended and are potentially harmful in patients with pre-excited AF.	III	B
---	-----	---

Recommendations for the acute therapy of pre-excited AF**Haemodynamically stable patients**

Amiodarone (i.v.) is not recommended.	III	B
---------------------------------------	-----	---

Recommendations for the therapy of SVTs in congenital heart disease in adults**Chronic therapy**

Sotalol is not recommended as a first-line antiarrhythmic drug as it is related to an increased risk of pro-arrhythmias and mortality.	III	C
--	-----	---

Flecainide and propafenone are not recommended as first-line antiarrhythmic drugs in patients with ventricular dysfunction and severe fibrosis.	III	C
---	-----	---

Recommendations for the therapy of SVT in pregnancy**Chronic therapy**

Amiodarone is not recommended in pregnant women.	III	C
--	-----	---

AF = atrial fibrillation; AP = accessory pathway; AT = atrial tachycardia; AVNRT = atrioventricular nodal re-entrant tachycardia; AVRT = atrioventricular re-entrant tachycardia; CTI = cavotricuspid isthmus; DC = direct current; ECG = electrocardiogram; EPS = electrophysiology study; ERP = effective refractory period; HF = heart failure; i.v. = intravenous; MRAT = macro-re-entrant atrial tachycardia; SPERRI = shortest pre-excited RR interval during atrial fibrillation; SVT = supraventricular tachycardia; TCM = tachycardiomyopathy.

^aClass of recommendation.

^bLevel of evidence.

21 Areas for further research

With the advent of catheter ablation in the 1990s, resulting in the successful elimination of APs in symptomatic patients, AVRT now represents <20% of all SVTs.^{11,13} The frequency of AVNRT, which used to account for 50% of all SVT cases,¹⁴ has changed to ~30%,^{11,13} and the proliferation of AF ablation will unavoidably result in more iatrogenic left atrial MRAT. Moreover, the prolonged survival of paediatric and ACHD patients is expected to impose a further challenge on electrophysiologists, who will encounter even more complex MRATs. Several important advances in the field of anatomical and electrical mapping, as well as our appreciation of scar tissue and the transmural of ablation lesions, should improve our efficiency in treating these patients.

The past decade has witnessed a rapid evolution of ablation equipment and electrode-guiding systems, which has resulted in more controllable and safer procedures. Intracardiac echocardiography, robotic techniques, and sophisticated anatomical navigation systems have been developed, and it is now possible to perform ablation without exposing the operator to radiation and ergonomically unfavourable positions.⁵⁸¹ New materials for electrodes and other equipment have allowed the concept of a radiation-free electrophysiology laboratory with the use of CMR. The vision of a fully radiation-free, magnetic laboratory in the future is not science fiction anymore.⁵⁸²

The revolution in computer technology offers not only improved mapping and electrode-moving systems, but also the enhancement of specific SVT classification schemes with fully automated algorithms that may greatly assist emergency departments, ambulances, and monitored patients.⁵⁸³ Mathematical modelling and numerical analyses have also been employed in the investigation of the circuit of AVNRT.^{317,329} Further analysis of recorded ECGs using fast Fourier and Gaussian models may also provide useful diagnostic information about the nature of the tachycardia. Novel electroanatomical mapping systems are being developed to assist the identification of the tachycardia mechanism and optimal ablation site of SVT, and, especially, complex atrial macro-re-entrant tachycardias, with reduced fluoroscopy times.^{584–589} Systems are now available that allow the simultaneous visualization of activation and voltage. The implications that these may have on characterizing the tachycardia substrate, and not just the circuit, require future research.

New data on the genetics of SVT continually appear since the identification of a missense mutation in the *PRKAG2* gene, which encodes the regulatory γ -subunit of adenosine monophosphate (AMP)-activated protein kinase, as a cause of familial WPW syndrome.^{590,591} The R302Q mutation in *PRKAG2* has been associated with Mahaim fibers.⁵⁹² A novel form of WPW syndrome is associated with microdeletion of the *BMP2* gene, which encodes bone morphogenetic protein-2, a member of the transforming growth factor-beta gene superfamily, and affects the development of annulus fibrosus.⁵⁹³ Other rare, genetic forms of pre-excitation have also been described.³⁹⁸ Whether this kind of genetic predisposition translates into a higher ventricular fibrillation risk remains to be seen. Genetic animal models of WPW that express mutations (such as of the gene encoding the AMP-activated protein kinase) responsible for a familial form of WPW syndrome with a phenotype identical to that of the human syndrome have been developed, and may provide insight into the development and properties of the cardiac conduction system and APs.⁵⁹⁴ Spontaneous AVNRT has also been

identified as a potential first clinical manifestation of concealed Brugada syndrome, particularly in female patients.⁵⁹⁵ It has been postulated that genetic variants that reduce the sodium current may predispose individuals to expression of both phenotypes. Cellular electrophysiology is now being integrated into genetic analysis. The coupling of whole-exome sequencing with cellular electrophysiological functional analysis may elucidate the underlying pathophysiological mechanism responsible for certain phenotypes.⁵⁹⁶ Recently, a familial form of IST was shown to be associated with a gain-of-function mutation in the *HCN4* pacemaker channel (R524Q), conferring an increased sensitivity to the second messenger cyclic AMP, which is a key mediator in sympathetic modulation.⁵⁹⁷ These developments may have important implications for a more specific diagnostic and personalized therapeutic approach in SVT. Future research should define actionable patient-specific molecular arrhythmia mechanisms, clarify the responses of the underlying substrates to interventions, and achieve selective supraventricular targeting of specific arrhythmic mechanisms with drugs.

SVTs are not only an everyday clinical problem, with AVNRT being the most common regular arrhythmia in humans. They also provide the background for proper training of future electrophysiologists by means of their well-defined circuits, in most cases, and predictable responses in the electrophysiology laboratory. In the era of computerized approaches that are now available for AF, complex AT, and VT ablation, this is very important for a rational, Aristotelian approach to the art of medicine.⁵⁹⁸

22 Supplementary data

Supplementary Data with additional Supplementary Figures and text complementing the full text, as well as sections on the electrophysiological mechanisms of SVT, tachycardia circuits, and cardiac anatomy for the electrophysiologist, along with the related supplementary references, are available on the *European Heart Journal* website and via the ESC website at www.escardio.org/guidelines.

23 Appendix

Author/Task Force Member Affiliations

Elena Arbelo, Arrhythmia Unit, Cardiovascular Institute, Hospital Clinic de Barcelona, Universitat de Barcelona, Spain; Cardiovascular Institute, Hospital Clínic, Universitat de Barcelona, Barcelona, Spain; and Institut d'Investigació August Pi i Sunyer (IDIBAPS), Centro de Investigación Biomédica en Red de Enfermedades; Barcelona, Spain; **Fernando Arribas**, Department of Cardiology, Hospital 12 de Octubre, Madrid, Spain; **Jeroen J. Bax**, Cardiology, Leiden University Medical Center, Leiden, Netherlands; **Carina Blomström-Lundqvist**, Department of Medical Science and Cardiology, Uppsala University, Uppsala, Sweden; **Hugh Calkins**, Cardiology, Johns Hopkins Medical Institutions, Baltimore, United States of America; **Spyridon G. Deftereos**, 2nd Department of Cardiology, National and Kapodistrian University of Athens, Athens, Greece; **Gerhard-Paul Diller**, Cardiology III, University Hospital Muenster, Muenster, Germany; **Juan J. Gomez-Doblas**, Cardiology, Hospital Universitario Virgen de la Victoria, CIBERG, Malaga, Spain; **Bulent Gorenek**, Cardiology Department, Eskisehir Osmangazi University, Turkey; **Andrew Grace**, Department of Cardiology, Royal Papworth Hospital NHS Foundation

Trust, Cambridge University Health Partners, Cambridge, United Kingdom; **Siew Yen Ho**, Cardiac Morphology, Royal Brompton Hospital, London, United Kingdom; **Juan-Carlos Kaski**, Molecular and Clinical Sciences Research Institute, St George's University of London, London, United Kingdom; **Karl-Heinz Kuck**, Cardiology, Asklepios Klinik St. Georg, Hamburg, Germany; **Pier David Lambiase**, Cardiology, UCL & Barts Heart Centre, London, United Kingdom; **Frederic Sacher**, Service de Rythmologie, IHU LIRYC/Bordeaux University Hospital, Bordeaux, France; **Georgia Sarquella-Brugada**, Arrhythmia, Inherited Cardiac Disease and Sudden Death Unit, Hospital Sant Joan de Déu, Barcelona, Spain; **Piotr Suwalski**, Central Clinical Hospital of the Ministry of Interior and Administration, Centre of Postgraduate Medical Education, Warsaw, Poland; **Antonio Zaza**, Università degli Studi Milano-Bicocca, Dipartimento di Biotecnologie e Bioscienze, Bldg U3, p.za della Scienza 2, 20126 Milano, Italy.

ESC Committee for Practice Guidelines (CPG): Stephan Windecker (Chairperson) (Switzerland), Victor Aboyans (France), Colin Baigent (United Kingdom), Jean-Philippe Collet (France), Veronica Dean (France), Victoria Delgado (Netherlands), Donna Fitzsimons (United Kingdom), Chris P. Gale (United Kingdom), Diederick E. Grobbee (Netherlands), Sigrun Halvorsen (Norway), Gerhard Hindricks (Germany), Bernard Jung (France), Peter Jüni (Canada), Hugo A. Katus (Germany), Ulf Landmesser (Germany), Christophe Leclercq (France), Maddalena Lettino (Italy), Basil S. Lewis (Israel), Bela Merkely (Hungary), Christian Mueller (Switzerland), Steffen E. Petersen (United Kingdom), Anna Sonia Petronio (Italy), Dimitrios J. Richter (Greece), Marco Roffi (Switzerland), Evgeny Shlyakhto (Russian Federation), Iain A. Simpson (United Kingdom), Miguel Sousa-Uva (Portugal), Rhian M. Touyz (United Kingdom).

ESC National Cardiac Societies actively involved in the review process of the 2019 ESC Guidelines for the management of patients with supraventricular tachycardia:

Algeria: Algerian Society of Cardiology, Walid Amara; **Armenia:** Armenian Cardiologists Association, Svetlana Grigoryan; **Austria:** Austrian Society of Cardiology, Andrea Podczek-Schweighofer; **Belarus:** Belorussian Scientific Society of Cardiologists, Alexandr Chasnoits; **Belgium:** Belgian Society of Cardiology, Yves Vandekerckhove; **Bosnia and Herzegovina:** Association of Cardiologists of Bosnia and Herzegovina, Sekib Sokolovich; **Bulgaria:** Bulgarian Society of Cardiology, Vassil Traykov; **Croatia:** Croatian Cardiac Society, Bosko Skoric; **Cyprus:** Cyprus Society of Cardiology, Elias Papisavvas; **Czech Republic:** Czech Society of Cardiology, Josef Kautzner; **Denmark:** Danish Society of Cardiology, Sam Riahi; **Estonia:** Estonian Society of Cardiology, Priti Kampus; **Finland:** Finnish Cardiac Society, Hannu Parikka; **France:** French Society of Cardiology, Olivier Piot; **Georgia:** Georgian Society of Cardiology, Kakhaber Etsadashvili; **Germany:** German Cardiac Society, Christoph Stellbrink; **Greece:** Hellenic Society of Cardiology, Antonis S. Manolis; **Hungary:** Hungarian Society of Cardiology, Zoltán Csanádi; **Iceland:** Icelandic Society of Cardiology, Kristján Gudmundsson; **Ireland:** Irish Cardiac Society, John Erwin; **Israel:** Israel Heart Society, Alon Barsheshet; **Italy:** Italian Federation of Cardiology, Roberto De Ponti; **Kazakhstan:** Association of Cardiologists of Kazakhstan, Ayan Abdrakhmanov;

Kosovo (Republic of): Kosovo Society of Cardiology, Haki Jashari; **Kyrgyzstan:** Kyrgyz Society of Cardiology, Olga Lunegova; **Latvia:** Latvian Society of Cardiology, Kristine Jubele; **Lebanon:** Lebanese Society of Cardiology, Marwan M. Refaat; **Lithuania:** Lithuanian Society of Cardiology, Aras Puodziukynas; **Luxembourg:** Luxembourg Society of Cardiology, Laurent Groben; **Moldova (Republic of):** Moldavian Society of Cardiology, Aurel Grosu; **Montenegro:** Montenegro Society of Cardiology, Nikola Pavlovic; **Morocco:** Moroccan Society of Cardiology, Fellat Ibtissam; **Netherlands:** Netherlands Society of Cardiology, Serge A. Trines; **North Macedonia:** North Macedonian Society of Cardiology, Lidija Poposka; **Norway:** Norwegian Society of Cardiology, Kristina H. Haugaa; **Poland:** Polish Cardiac Society, Oskar Kowalski; **Portugal:** Portuguese Society of Cardiology, Diogo Cavaco; **Romania:** Romanian Society of Cardiology, Dan Dobreanu; **Russian Federation:** Russian Society of Cardiology, Evgeny N. Mikhaylov; **San Marino:** San Marino Society of Cardiology, Marco Zavatta; **Serbia:** Cardiology Society of Serbia, Mujović Nebojša; **Slovakia:** Slovak Society of Cardiology, Peter Hlivak; **Spain:** Spanish Society of Cardiology, Ignacio Ferreira-Gonzalez; **Sweden:** Swedish Society of Cardiology, Tord Juhlin; **Switzerland:** Swiss Society of Cardiology, Tobias Reichlin; **Tunisia:** Tunisian Society of Cardiology and Cardio-Vascular Surgery, Habib Haouala; **Turkey:** Turkish Society of Cardiology, Taylan Akgun; **United Kingdom of Great Britain and Northern Ireland:** British Cardiovascular Society, Dhiraj Gupta.

24 References

- Blomström-Lundqvist C, Scheinman MM, Aliot EM, Alpert JS, Calkins H, Camm AJ, Campbell WB, Haines DE, Kuck KH, Lerman BB, Miller DD, Shaeffer CW, Stevenson WG, Tomaselli GF. ACC/AHA/ESC guidelines for the management of patients with supraventricular arrhythmias—executive summary: a report of the American college of cardiology/American heart association task force on practice guidelines and the European society of cardiology committee for practice guidelines (writing committee to develop guidelines for the management of patients with supraventricular arrhythmias) developed in collaboration with NASPE-Heart Rhythm Society. *J Am Coll Cardiol* 2003;**42**:1493–1531.
- Page RL, Joglar JA, Caldwell MA, Calkins H, Conti JB, Deal BJ, Estes NAM, Field ME, Goldberger ZD, Hammill SC, Indik JH, Lindsay BD, Olshansky B, Russo AM, Shen W-K, Tracy CM, Al-Khatib SM. 2015 ACC/AHA/HRS guideline for the management of adult patients with supraventricular tachycardia: executive summary: a report of the American College of Cardiology/American Heart Association Task Force on Clinical Practice Guidelines and the Heart Rhythm Society. *J Am Coll Cardiol* 2016;**67**:1575–1623.
- Katritsis DG, Boriani G, Cosio FG, Hindricks G, Jais P, Josephson ME, Keegan R, Kim Y-H, Knight BP, Kuck K-H, Lane DA, Lip GYH, Malmberg H, Oral H, Pappone C, Themistoclakis S, Wood KA, Blomström-Lundqvist C. European Heart Rhythm Association (EHRA) consensus document on the management of supraventricular arrhythmias, endorsed by Heart Rhythm Society (HRS), Asia-Pacific Heart Rhythm Society (APHRS), and Sociedad Latinoamericana de Estimulación Cardíaca y Electrofisiología (SOLAECE). *Eur Heart J* 2018;**39**:1442–1445.
- Kirchhof P, Benussi S, Kotecha D, Ahlsson A, Atar D, Casadei B, Castella M, Diener H-C, Heidbuchel H, Hendriks J, Hindricks G, Manolis AS, Oldgren J, Popescu BA, Schotten U, Van Putte B, Vardas P, Agewall S, Camm J, Baron Esquivias G, Budts W, Carerj S, Casselman F, Coca A, De Caterina R, Deftereos S, Dobrev D, Ferro JM, Filippatos G, Fitzsimons D, Gorenk B, Guenoun M, Hohloser SH, Kolh P, Lip GYH, Manolis A, McMurray J, Ponikowski P, Rosenhek R, Ruschitzka F, Savelieva I, Sharma S, Suwalski P, Tamargo JL, Taylor CJ, Van Gelder IC, Voors AA, Windecker S, Zamorano JL, Zeppenfeld K. 2016 ESC Guidelines for the management of atrial fibrillation developed in collaboration with EACTS. *Eur Heart J* 2016;**37**:2893–2962.
- Calkins H, Hindricks G, Cappato R, Kim YH, Saad EB, Aguinaga L, Akar JG, Badhwar V, Brugada J, Camm J, Chen PS, Chen SA, Chung MK, Nielsen JC, Curtis AB, Davies DW, Day JD, d'Avila A, de Groot N, Di Biase L, Duytschaever M, Edgerton JR, Ellenbogen KA, Ellinor PT, Ernst S, Fenelon G, Gerstenfeld EP,

- Haines DE, Haissaguerre M, Helm RH, Hylek E, Jackman WM, Jalife J, Kalman JM, Kottkuner J, Kottkamp H, Kuck KH, Kumagai K, Lee R, Lewalter T, Lindsay BD, Macle L, Mansour M, Marchlinski FE, Michaud GF, Nakagawa H, Natale A, Nattel S, Okumura K, Packer D, Pokushalov E, Reynolds MR, Sanders P, Scanavacca M, Schilling R, Tondo C, Tsao HM, Verma A, Wilber DJ, Yamane T. 2017 HRS/EHRA/ECAS/APHRS/SOLAECE expert consensus statement on catheter and surgical ablation of atrial fibrillation: executive summary. *Europace* 2018;**20**:157–208.
6. Mairesse GH, Moran P, Van Gelder IC, Elsner C, Rosenqvist M, Mant J, Banerjee A, Gorennek B, Brachmann J, Varma N, Glotz de Lima G, Kalman J, Claes N, Lobban T, Lane D, Lip GYH, Boriani G; ESC Scientific Document Group. Screening for atrial fibrillation: a European Heart Rhythm Association (EHRA) consensus document endorsed by the Heart Rhythm Society (HRS), Asia Pacific Heart Rhythm Society (APHRS), and Sociedad Latinoamericana de Estimulación Cardíaca y Electrofisiología (SOLAECE). *Europace* 2017;**19**:1589–1623.
 7. Lip GYH, Collet JP, Haude M, Huber K. Management of antithrombotic therapy in AF patients presenting with ACS and/or undergoing PCI: a summary of the Joint Consensus Document of the European Heart Rhythm Association (EHRA), European Society of Cardiology Working Group on Thrombosis, European Association of Percutaneous Cardiovascular Interventions (EAPCI) and European Association of Acute Cardiac Care (ACCA) endorsed by the Heart Rhythm Society (HRS), Asia-Pacific Heart Rhythm Society (APHRS), Latin America Heart Rhythm Society (LAHRS), and Cardiac Arrhythmia Society of Southern Africa (CASSA). *Eur Heart J* 2018;**39**:2847–2850.
 8. Wit AL, Wellens HJ, Josephson ME. *Electrophysiological foundations of cardiac arrhythmias*. 1st ed. Minneapolis: Cardiotext Publishing; 2017.
 9. Orejarena LA, Vidaillet H, DeStefano F, Nordstrom DL, Vierkant RA, Smith PN, Hayes JJ. Paroxysmal supraventricular tachycardia in the general population. *J Am Coll Cardiol* 1998;**31**:150–157.
 10. Wu M-H, Chen H-C, Kao F-Y, Huang S-K. Postnatal cumulative incidence of supraventricular tachycardia in a general pediatric population: a national birth cohort database study. *Heart Rhythm* 2016;**13**:2070–2075.
 11. García-Fernández FJ, Ibáñez Criado JL, Quesada Dorador A; collaborators of the Spanish Catheter Ablation Registry; REGISTRY COLLABORATORS. Spanish Catheter Ablation Registry. 17th Official Report of the Spanish Society of Cardiology Working Group on Electrophysiology and Arrhythmias (2017). *Rev Esp Cardiol (Engl Ed)* 2018;**71**:941–951.
 12. Hosseini SM, Rozen G, Saleh A, Vaid J, Biton Y, Moazzami K, Heist EK, Mansour MC, Kaadan MI, Vangel M, Ruskin JN. Catheter ablation for cardiac arrhythmias: utilization and in-hospital complications, 2000 to 2013. *JACC Clin Electrophysiol* 2017;**3**:1240–1248.
 13. Holmqvist F, Kesek M, Englund A, Blomström-Lundqvist C, Karlsson LO, Kenneback G, Poçi D, Samo-Ayuru R, Sigurjónsdóttir R, Ringborn M, Herczku C, Carlson J, Fjengrud E, Tabrizi F, Höglund N, Lönnholm S, Kongstad O, Jönsson A, Insulander P. A decade of catheter ablation of cardiac arrhythmias in Sweden: ablation practices and outcomes. *Eur Heart J* 2019;**40**:820–830.
 14. Porter MJ, Morton JB, Denman R, Lin AC, Tierney S, Santucci PA, Cai JJ, Madsen N, Wilber DJ. Influence of age and gender on the mechanism of supraventricular tachycardia. *Heart Rhythm* 2004;**1**:393–396.
 15. Gonzalez-Torrecilla E, Almendral J, Arenal A, Atienza F, Atea LF, del Castillo S, Fernandez-Aviles F. Combined evaluation of bedside clinical variables and the electrocardiogram for the differential diagnosis of paroxysmal atrioventricular reciprocating tachycardias in patients without pre-excitation. *J Am Coll Cardiol* 2009;**53**:2353–2358.
 16. Liuba I, Jönsson A, Säfström K, Walfridsson H. Gender-related differences in patients with atrioventricular nodal reentry tachycardia. *Am J Cardiol* 2006;**97**:384–388.
 17. Rosano GMC, Leonardo F, Rosano GMC, De Luca F, Sarrel PM, Beale CM, Collins P. Cyclical variation in paroxysmal supraventricular tachycardia in women. *Lancet* 1996;**347**:786–788.
 18. Chang S-H, Kuo C-F, Chou I-J, See L-C, Yu K-H, Luo S-F, Chiou M-J, Zhang W, Doherty M, Wen M-S, Chen W-J, Yeh Y-H. Outcomes associated with paroxysmal supraventricular tachycardia during pregnancy. *Circulation* 2017;**135**:616–618.
 19. Krahn AD, Manfreda J, Tate RB, Mathewson FL, Cuddy T. The natural history of electrocardiographic preexcitation in men: the Manitoba Follow-up Study. *Ann Intern Med* 1992;**116**:456–460.
 20. Vidaillet HJJ, Pressley JC, Henke E, Harrell FEJ, German LD. Familial occurrence of accessory atrioventricular pathways (preexcitation syndrome). *N Engl J Med* 1987;**317**:65–69.
 21. Lu C-W, Wu M-H, Chen H-C, Kao F-Y, Huang S-K. Epidemiological profile of Wolff-Parkinson-White syndrome in a general population younger than 50 years of age in an era of radiofrequency catheter ablation. *Int J Cardiol* 2014;**174**:530–534.
 22. Skov MW, Rasmussen PV, Ghouse J, Hansen SM, Graff C, Olesen MS, Pietersen A, Torp-Pedersen C, Haunsø S, Køber L, Svendsen JH, Holst AG, Nielsen JB. Electrocardiographic preexcitation and risk of cardiovascular morbidity and mortality. Results from the Copenhagen ECG Study. *Circ Arrhythm Electrophysiol* 2017;**10**:e004778.
 23. Granada J, Uribe W, Chyou P-H, Maassen K, Vierkant R, Smith PN, Hayes J, Eaker E, Vidaillet H. Incidence and predictors of atrial flutter in the general population. *J Am Coll Cardiol* 2000;**36**:2242–2246.
 24. Withers KL, White J, Carolan-Rees G, Patrick H, O'Callaghan P, Murray S, Cunningham D, Wood KA, Lencioni M, Griffith M. Patient reported outcome measures for cardiac ablation procedures: a multicentre pilot to develop a new questionnaire. *Europace* 2014;**16**:1626–1633.
 25. Wood KA, Stewart AL, Drew BJ, Scheinman MM, Froelicher ES. Patient perception of symptoms and quality of life following ablation in patients with supraventricular tachycardia. *Heart Lung* 2010;**39**:12–20.
 26. White J, Withers KL, Lencioni M, Carolan-Rees G, Wilkes AR, Wood KA, Patrick H, Cunningham D, Griffith M. Cardiff cardiac ablation patient-reported outcome measure (C-CAP): validation of a new questionnaire set for patients undergoing catheter ablation for cardiac arrhythmias in the UK. *Qual Life Res* 2016;**25**:1571–1583.
 27. Brachmann J, Lewalter T, Kuck KH, Andresen D, Willems S, Spitzer SG, Straube F, Schumacher B, Eckardt L, Danilovic D, Thomas D, Hochadel M, Senges J. Long-term symptom improvement and patient satisfaction following catheter ablation of supraventricular tachycardia: insights from the German ablation registry. *Eur Heart J* 2017;**38**:1317–1326.
 28. Farkowski MM, Pytkowski M, Maciag A, Golicki D, Wood KA, Kowalik I, Kuteszko R, Szwed H. Gender-related differences in outcomes and resource utilization in patients undergoing radiofrequency ablation of supraventricular tachycardia: results from Patients' Perspective on Radiofrequency Catheter Ablation of AVRT and AVNRT Study. *Europace* 2014;**16**:1821–1827.
 29. Feldman A, Voskoboinik A, Kumar S, Spence S, Morton JB, Kistler PM, Sparks PB, Vohra JK, Kalman JM. Predictors of acute and long-term success of slow pathway ablation for atrioventricular nodal reentrant tachycardia: a single center series of 1,419 consecutive patients. *Pacing Clin Electrophysiol* 2011;**34**:927–933.
 30. Zimetbaum P, Josephson ME. Evaluation of patients with palpitations. *N Engl J Med* 1998;**338**:1369–1373.
 31. Page RL, Wilkinson WE, Clair WK, McCarthy EA, Pritchett EL. Asymptomatic arrhythmias in patients with symptomatic paroxysmal atrial fibrillation and paroxysmal supraventricular tachycardia. *Circulation* 1994;**89**:224–227.
 32. Thavendiranathan P, Bagai A, Khoo C, Dorian P, Choudhry NK. Does this patient with palpitations have a cardiac arrhythmia? *JAMA* 2009;**302**:2135–2143.
 33. Leitch JW, Klein GJ, Yee R, Leather RA, Kim YH. Syncope associated with supraventricular tachycardia. An expression of tachycardia rate or vasomotor response? *Circulation* 1992;**85**:1064–1071.
 34. Thiruganasambandamoorthy V, Rowe BH, Sivilotti MLA, McRae AD, Arcot K, Nemnom MJ, Huang L, Mukarram M, Krahn AD, Wells GA, Taljaard M. Duration of electrocardiographic monitoring of emergency department patients with syncope. *Circulation* 2019;**139**:1396–1406.
 35. Razavi M, Luria DM, Jahangir A, Hodge DO, Low PA, Shen W-K. Acute blood pressure changes after the onset of atrioventricular nodal reentrant tachycardia: a time-course analysis. *J Cardiovasc Electrophysiol* 2005;**16**:1037–1040.
 36. Abe H, Nagatomo T, Kobayashi H, Miura Y, Araki M, Kuroiwa A, Nakashima Y. Neurohumoral and hemodynamic mechanisms of diuresis during atrioventricular nodal reentrant tachycardia. *Pacing Clin Electrophysiol* 1997;**20**(11):2783–2788.
 37. Chinen S, Miura M, Tamame T, Matsuoka M, Ohki H, Sumitomo N. Life-threatening atrial tachycardia after the Senning operation in a patient with transposition of the great arteries. *Heart Vessels* 2012;**27**:424–427.
 38. Gürsoy S, Steurer G, Brugada J, Andries E, Brugada P. The hemodynamic mechanism of pounding in the neck in atrioventricular nodal reentrant tachycardia. *N Engl J Med* 1992;**327**:772–774.
 39. Contreras-Valdes FM, Josephson ME. IMAGES IN CLINICAL MEDICINE. "Frog sign" in atrioventricular nodal reentrant tachycardia. *N Engl J Med* 2016;**374**:e17.
 40. Lessmeier TJ, Gamperling D, Johnson-Liddon V, Fromm BS, Steinman RT, Meissner MD, Lehmann MH. Unrecognized paroxysmal supraventricular tachycardia: potential for misdiagnosis as panic disorder. *Arch Intern Med* 1997;**157**:537–543.
 41. Appelboam A, Reuben A, Mann C, Gagg J, Ewings P, Barton A, Lobban T, Dayer M, Vickery J, Bengler J. Postural modification to the standard Valsalva manoeuvre for emergency treatment of supraventricular tachycardias (REVERT): a randomised controlled trial. *Lancet* 2015;**386**:1747–1753.
 42. Wang R, Blackburn G, Desai M, Phelan D, Gillinov L, Houghtaling P, Gillinov M. Accuracy of wrist-worn heart rate monitors. *JAMA Cardiol* 2017;**2**:104–106.
 43. Katritsis DG, Mark DB, Gersh BJ. Revascularization in stable coronary disease: evidence and uncertainties. *Nat Rev Cardiol* 2018;**15**:408–419.
 44. Michowitz Y, Tovia-Brodie O, Heusler I, Sabbag A, Rahkovich M, Shmueli H, Glick A, Belhassen B. Differentiating the QRS morphology of posterior fascicular ventricular tachycardia from right bundle branch block and left anterior hemiblock aberrancy. *Circ Arrhythm Electrophysiol* 2017;**10**:e005074.
 45. Katritsis DG, Josephson ME. Differential diagnosis of regular, narrow-QRS tachycardias. *Heart Rhythm* 2015;**12**:1667–1676.

46. Roberts-Thomson KC, Kistler PM, Kalman JM. Focal atrial tachycardia I: clinical features, diagnosis, mechanisms, and anatomic location. *Pacing Clin Electrophysiol* 2006;**29**:643–652.
47. Katritsis DG, Becker A. The atrioventricular nodal reentrant tachycardia circuit: a proposal. *Heart Rhythm* 2007;**4**:1354–1360.
48. Jais P, Matsuo S, Knecht S, Weerasooriya R, Hocini M, Sacher F, Wright M, Nault I, Lellouche N, Klein G, Clémenty J, Haïssaguerre M. A deductive mapping strategy for atrial tachycardia following atrial fibrillation ablation: importance of localized reentry. *J Cardiovasc Electrophysiol* 2009;**20**:480–491.
49. Green M, Heddle B, Dassen W, Wehr M, Abdollah H, Brugada P, Wellens HJ. Value of QRS alteration in determining the site of origin of narrow QRS supra-ventricular tachycardia. *Circulation* 1983;**68**:368–373.
50. Chen SA, Tai CT, Chiang CE, Chang MS. Role of the surface electrocardiogram in the diagnosis of patients with supraventricular tachycardia. *Cardiol Clin* 1997;**15**:539–565.
51. Morady F. Significance of QRS alternans during narrow QRS tachycardias. *Pacing Clin Electrophysiol* 1991;**14**:2193–2198.
52. Crawford TC, Mukerji S, Good E, Chugh A, Bogun F, Pelosi F, Oral H, Morady F, Jongnarangsin K. Utility of atrial and ventricular cycle length variability in determining the mechanism of paroxysmal supraventricular tachycardia. *J Cardiovasc Electrophysiol* 2007;**18**:698–703.
53. Bogossian H, Ninios I, Frommeyer G, Bandorski D, Eckardt L, Lemke B, Zarse M. U wave during supraventricular tachycardia: simulation of a long RP tachycardia and hiding the common type AVNRT. *Ann Noninvasive Electrocardiol* 2015;**20**:292–295.
54. Nagashima K, Watanabe I, Okumura Y, Kaneko Y, Sonoda K, Kogawa R, Sasaki N, Iso K, Takahashi K, Kurokawa S, Nakai T, Ohkubo K, Hirayama A. Ventriculoatrial intervals ≤ 70 ms in orthodromic atrioventricular reciprocating tachycardia. *Pacing Clin Electrophysiol* 2016;**39**:1108–1115.
55. Letsas KP, Weber R, Herrera Siklódy C, Mihás CC, Stockinger J, Blum T, Kalusche D, Arentz T. Electrocardiographic differentiation of common type atrioventricular nodal reentrant tachycardia from atrioventricular reciprocating tachycardia via a concealed accessory pathway. *Acta Cardiologica* 2010;**65**:171–176.
56. Kalbfleisch SJ, el-Atassi R, Calkins H, Langberg JJ, Morady F. Differentiation of paroxysmal narrow QRS complex tachycardias using the 12-lead electrocardiogram. *J Am Coll Cardiol* 1993;**21**:85–89.
57. Tai CT, Chen SA, Chiang CE, Lee SH, Wen ZC, Chiou CW, Ueng KC, Chen YJ, Yu WC, Chang MS. A new electrocardiographic algorithm using retrograde P waves for differentiating atrioventricular node reentrant tachycardia from atrioventricular reciprocating tachycardia mediated by concealed accessory pathway. *J Am Coll Cardiol* 1997;**29**:394–402.
58. Di Toro D, Hadid C, López C, Fuselli J, Luis V, Labadet C. Utility of the aVL lead in the electrocardiographic diagnosis of atrioventricular node re-entrant tachycardia. *Europace* 2009;**11**:944–948.
59. Haghjoo M, Bahramali E, Sharifkazemi M, Shahrzad S, Peighambari M. Value of the aVR lead in differential diagnosis of atrioventricular nodal reentrant tachycardia. *Europace* 2012;**14**:1624–1628.
60. Knight BP, Ebinger M, Oral H, Kim MH, Sticherling C, Pelosi F, Michaud GF, Strickberger SA, Morady F. Diagnostic value of tachycardia features and pacing maneuvers during paroxysmal supraventricular tachycardia. *J Am Coll Cardiol* 2000;**36**:574–582.
61. Markowitz SM, Stein KM, Mittal S, Slotwtner DJ, Lerman BB. Differential effects of adenosine on focal and macroreentrant atrial tachycardia. *J Cardiovasc Electrophysiol* 1999;**10**:489–502.
62. Alzand BSN, Manusama R, Gorgels APM, Wellens HJJ. An “almost wide” QRS tachycardia. *Circ Arrhythm Electrophysiol* 2009;**2**:e1–e3.
63. Alzand BSN, Crijns HJ. Diagnostic criteria of broad QRS complex tachycardia: decades of evolution. *Europace* 2011;**13**:465–472.
64. Stewart RB, Bardy GH, Greene H. Wide complex tachycardia: misdiagnosis and outcome after emergent therapy. *Ann Intern Med* 1986;**104**:766–771.
65. Wellens HJJ. Ventricular tachycardia: diagnosis of broad QRS complex tachycardia. *Heart* 2001;**86**:579–585.
66. Willems S, Shenasa M, Borggreve M, Hindricks G, Chen X, Rotman B, Kottkamp H, Haverkamp W, Breithardt G. Atrioventricular nodal reentry tachycardia: electrophysiologic comparisons in patients with and without 2:1 infra-His block. *Clin Cardiol* 1993;**16**:883–888.
67. Ranger S, Talajic M, Lemery R, Roy D, Villemaire C, Nattel S. Kinetics of use-dependent ventricular conduction slowing by antiarrhythmic drugs in humans. *Circulation* 1991;**83**:1987–1994.
68. Jastrzebski M, Kukla P, Czarnecka D, Kawecka-Jaszcz K. Comparison of five electrocardiographic methods for differentiation of wide QRS-complex tachycardias. *Europace* 2012;**14**:1165–1171.
69. Brugada P, Brugada J, Mont L, Smeets J, Andries EW. A new approach to the differential diagnosis of a regular tachycardia with a wide QRS complex. *Circulation* 1991;**83**:1649–1659.
70. Kindwall KE, Brown J, Josephson ME. Electrocardiographic criteria for ventricular tachycardia in wide complex left bundle branch block morphology tachycardias. *Am J Cardiol* 1988;**61**:1279–1283.
71. Vereckei A, Duray G, Szénási G, Altemose GT, Miller JM. New algorithm using only lead aVR for differential diagnosis of wide QRS complex tachycardia. *Heart Rhythm* 2008;**5**:89–98.
72. Pava LF, Perafán P, Badiel M, Arango JJ, Mont L, Morillo CA, Brugada J. R-wave peak time at DII: a new criterion for differentiating between wide complex QRS tachycardias. *Heart Rhythm* 2010;**7**:922–926.
73. Steurer G, Gursoy S, Frey B, Simonis F, Andries E, Kuck K, Brugada P. The differential diagnosis on the electrocardiogram between ventricular tachycardia and preexcited tachycardia. *Clin Cardiol* 1994;**17**:306–308.
74. Jastrzebski M, Moskal P, Kukla P, Fijorek K, Kisiel R, Czarnecka D. Specificity of wide QRS complex tachycardia criteria and algorithms in patients with ventricular preexcitation. *Ann Noninvasive Electrocardiol* 2018;**23**:e12493.
75. Alberca T, Almendral J, Sanz P, Almazan A, Cantalapiedra JL, Delcán JL. Evaluation of the specificity of morphological electrocardiographic criteria for the differential diagnosis of wide QRS complex tachycardia in patients with intra-ventricular conduction defects. *Circulation* 1997;**96**:3527–3533.
76. Ceresnak SR, Liberman L, Avasarala K, Tanel R, Motonaga KS, Dubin AM. Are wide complex tachycardia algorithms applicable in children and patients with congenital heart disease? *J Electrocardiol* 2010;**43**:694–700.
77. Jastrzebski M, Kukla P, Czarnecka D, Kawecka-Jaszcz K. Specificity of the wide QRS complex tachycardia algorithms in recipients of cardiac resynchronization therapy. *J Electrocardiol* 2012;**45**:319–326.
78. Lau EW, Ng GA. Comparison of the performance of three diagnostic algorithms for regular broad complex tachycardia in practical application. *Pacing Clin Electrophysiol* 2002;**25**:822–827.
79. Isenhour JL, Craig S, Gibbs M, Littmann L, Rose G, Risch R. Wide-complex tachycardia: continued evaluation of diagnostic criteria. *Acad Emerg Med* 2000;**7**:769–773.
80. Baxi RP, Hart KW, Vereckei A, Miller J, Chung S, Chang W, Gottesman B, Hunt M, Culyer G, Trimarco T, Willoughby C, Suarez G, Lindsell CJ, Collins SP. Vereckei criteria as a diagnostic tool amongst emergency medicine residents to distinguish between ventricular tachycardia and supra-ventricular tachycardia with aberrancy. *J Cardiol* 2012;**59**:307–312.
81. Jastrzebski M, Sasaki K, Kukla P, Fijorek K, Stec S, Czarnecka D. The ventricular tachycardia score: a novel approach to electrocardiographic diagnosis of ventricular tachycardia. *Europace* 2016;**18**:578–584.
82. Yadav AV, Nazer B, Drew BJ, Miller JM, El Masry H, Groh WJ, Natale A, Marrouche N, Badhwar N, Yang Y, Scheinman MM. Utility of conventional electrocardiographic criteria in patients with idiopathic ventricular tachycardia. *JACC Clin Electrophysiol* 2017;**3**:669–677.
83. Knight BP, Zivin A, Souza J, Goyal R, Man KC, Strickberger A, Morady F. Use of adenosine in patients hospitalized in a university medical center. *Am J Med* 1998;**105**:275–280.
84. Jolobe OMP. Caveats in preexcitation-related atrial fibrillation. *Am J Emerg Med* 2010;**28**:252–253.
85. Murman DH, McDonald AJ, Pelletier AJ, Camargo CA. U.S. Emergency Department Visits for Supraventricular Tachycardia, 1993–2003. *Acad Emerg Med* 2007;**14**(6):578–581.
86. Roth A, Elkayam I, Shapira I, Sander J, Malov N, Kehati M, Golovner M. Effectiveness of prehospital synchronous direct-current cardioversion for supra-ventricular tachyarrhythmias causing unstable hemodynamic states. *Am J Cardiol* 2003;**91**:489–491.
87. Wittwer MR, Rajendran S, Kealley J, Arstall MA. A South Australian registry of biphasic cardioversions of atrial arrhythmias: efficacy and predictors of success. *Heart Lung Circ* 2015;**24**:342–347.
88. Reisinger J, Gstrein C, Winter T, Zeindhofer E, Höllinger K, Mori M, Schiller A, Winter A, Geiger H, Siostrzonek P. Optimization of initial energy for cardioversion of atrial tachyarrhythmias with biphasic shocks. *Am J Emerg Med* 2010;**28**:159–165.
89. Smith GD, Fry MM, Taylor D, Morgans A, Cantwell K. Effectiveness of the Valsalva Manoeuvre for reversion of supraventricular tachycardia. *Cochrane Database Syst Rev* 2015;**2**:CD009502.
90. Lim SH, Anantharaman V, Teo WS, Goh PP, Tan ATH. Comparison of treatment of supraventricular tachycardia by Valsalva maneuver and carotid sinus massage. *Ann Emerg Med* 1998;**31**:30–35.
91. Smith G, Morgans A, Boyle M. Use of the Valsalva manoeuvre in the prehospital setting: a review of the literature. *Emerg Med J* 2009;**26**:8–10.
92. Brady WJ, DeBehne DJ, Wickman LL, Lindbeck G. Treatment of out-of-hospital supraventricular tachycardia: adenosine vs verapamil. *Acad Emerg Med* 1996;**3**(6):574–585.
93. Glatter KA, Cheng J, Dorostkar P, Modin G, Talwar S, Al-Nimri M, Lee RJ, Saxon LA, Lesh MD, Scheinman MM. Electrophysiologic effects of adenosine in patients with supraventricular tachycardia. *Circulation* 1999;**99**:1034–1040.

94. Delaney B, Loy J, Kelly A-M. The relative efficacy of adenosine versus verapamil for the treatment of stable paroxysmal supraventricular tachycardia in adults: a meta-analysis. *Eur J Emerg Med* 2011;**18**:148–152.
95. Dougherty AH, Jackman WM, Naccarelli GV, Friday KJ, Dias VC. Acute conversion of paroxysmal supraventricular tachycardia with intravenous diltiazem. *Am J Cardiol* 1992;**70**:587–592.
96. Hood MA, Smith WM. Adenosine versus verapamil in the treatment of supraventricular tachycardia: A randomized double-crossover trial. *Am Heart J* 1992;**123**:1543–1549.
97. Gupta A, Naik A, Vora A, Lokhandwala Y. Comparison of efficacy of intravenous diltiazem and esmolol in terminating supraventricular tachycardia. *J Assoc Physicians India* 1999;**47**:969–972.
98. Lim SH, Anantharaman V, Teo WS, Chan YH. Slow infusion of calcium channel blockers compared with intravenous adenosine in the emergency treatment of supraventricular tachycardia. *Resuscitation* 2009;**80**:523–528.
99. Das G, Tschida V, Gray R, Dhurandhar R, Lester R, McGrew F, Askenazi J, Kaplan K, Emanuele M, Turlapaty P, Hua TA, Hoff J, Allin D, Laddu A. Efficacy of esmolol in the treatment and transfer of patients with supraventricular tachyarrhythmias to alternate oral antiarrhythmic agents. *J Clin Pharmacol* 1988;**28**:746–750.
100. Amsterdam EA, Kulcyski J, Ridgeway MG. Efficacy of cardioselective beta-adrenergic blockade with intravenously administered metoprolol in the treatment of supraventricular tachyarrhythmias. *J Clin Pharmacol* 1991;**31**:714–718.
101. Smith G, Taylor DM, Morgans A, Cameron P. Prehospital synchronized electrical cardioversion of a poorly perfused SVT patient by paramedics. *Prehosp Disaster Med* 2013;**28**:301–304.
102. Wen Z-C, Chen S-A, Tai C-T, Chiang C-E, Chiou C-W, Chang M-S. Electrophysiological mechanisms and determinants of vagal maneuvers for termination of paroxysmal supraventricular tachycardia. *Circulation* 1998;**98**:2716–2723.
103. Taylor DM, Wong LF. Incorrect instruction in the use of the Valsalva manoeuvre for paroxysmal supra-ventricular tachycardia is common. *Emergency Medicine* 2004;**16**(4):284–287.
104. Smith G, Boyle MJ. The 10 mL syringe is useful in generating the recommended standard of 40 mmHg intrathoracic pressure for the Valsalva manoeuvre. *Emerg Med Australas* 2009;**21**:449–454.
105. Layland J, Carrick D, Lee M, Oldroyd K, Berry C. Adenosine: physiology, pharmacology, and clinical applications. *JACC Cardiovasc Interv* 2014;**7**:581–591.
106. Lerman BB, Markowitz SM, Cheung JW, Liu CF, Thomas G, Ip JE. Supraventricular tachycardia. *Circ Arrhythm Electrophysiol* 2018;**11**:e006953.
107. Camm AJ, Garratt CJ. Adenosine and supraventricular tachycardia. *N Engl J Med* 1991;**325**:1621–1629.
108. Ng GA, Martin W, Rankin AC. Imaging of adenosine bolus transit following intravenous administration: insights into antiarrhythmic efficacy. *Heart* 1999;**82**:163–169.
109. Alabed S, Sabouni A, Providencia R, Atallah E, Qintar M, Chico TJA. Adenosine versus intravenous calcium channel antagonists for supraventricular tachycardia. *Cochrane Database Syst Rev* 2017;**10**:CD005154.
110. Cabalag MS, Taylor DM, Knott JC, Buntine P, Smit D, Meyer A. Recent caffeine ingestion reduces adenosine efficacy in the treatment of paroxysmal supraventricular tachycardia. *Acad Emerg Med* 2010;**17**:44–49.
111. Karydes HC, Bryant SM. Adenosine and caffeine-induced paroxysmal supraventricular tachycardia. *Acad Emerg Med* 2010;**17**:570–570.
112. Burki NK, Wheeler JD, Lu-Yuan L. Intravenous adenosine and dyspnea in humans. *J Appl Physiol* (1985) 2005;**98**:180–185.
113. Fragakis N, Antoniadis AP, Korantzopoulos P, Kyriakou P, Koskinas KC, Geleris P. Sinus nodal response to adenosine relates to the severity of sinus node dysfunction. *Europace* 2012;**14**:859–864.
114. Ellenbogen KA, Thames MD, DiMarco JP, Sheehan H, Lerman BB. Electrophysiological effects of adenosine in the transplanted human heart. Evidence of supersensitivity. *Circulation* 1990;**81**:821–828.
115. Toft J, Mortensen J, Hesse B. Risk of atrioventricular block during adenosine pharmacologic stress testing in heart transplant recipients. *Am J Cardiol* 1998;**82**:696–697.
116. Flyer JN, Zuckerman WA, Richmond ME, Anderson BR, Mendelsberg TG, McAllister JM, Liberman L, Addonizio LJ, Silver ES. Prospective study of adenosine on atrioventricular nodal conduction in pediatric and young adult patients after heart transplantation. *Circulation* 2017;**135**:2485–2493.
117. Ip JE, Cheung JW, Chung JH, Liu CF, Thomas G, Markowitz SM, Lerman BB. Adenosine-induced atrial fibrillation. Insights into mechanism. *Circ Arrhythm Electrophysiol* 2013;**6**:e34–e37.
118. Li N, Csepe TA, Hansen BJ, Sul LV, Kalyanasundaram A, Zakharkin SO, Zhao J, Guha A, Van Wagoner DA, Kiliic A, Mohler PJ, Janssen PML, Biesiadecki BJ, Hummel JD, Weiss R, Fedorov VV. Adenosine-induced atrial fibrillation. Localized reentrant drivers in lateral right atria due to heterogeneous expression of adenosine A1 receptors and GIRK4 subunits in the human heart. *Circulation* 2016;**134**:486–498.
119. Turley AJ, Murray S, Thambyrajah J. Pre-excited atrial fibrillation triggered by intravenous adenosine: a commonly used drug with potentially life-threatening adverse effects. *Emerg Med J* 2008;**25**:46–48.
120. Garratt CJ, Griffith MJ, O'Nunain S, Ward DE, Camm AJ. Effects of intravenous adenosine on antegrade refractoriness of accessory atrioventricular connections. *Circulation* 1991;**84**:1962–1968.
121. Coli S, Mantovani F, Ferro J, Gonzi G, Zardini M, Ardissino D. Adenosine-induced severe bronchospasm in a patient without pulmonary disease. *Am J Emerg Med* 2012;**30**:2082.e3–2082.e5.
122. Cerqueira MD, Verani MS, Schwaiger M, Heo J, Iskandrian AS. Safety profile of adenosine stress perfusion imaging: results from the adenoscan multicenter trial registry. *J Am Coll Cardiol* 1994;**23**:384–389.
123. Balan KK, Critchley M. Is the dyspnea during adenosine cardiac stress test caused by bronchospasm? *Am Heart J* 2001;**142**:142–145.
124. Cushley MJ, Tattersfield AE, Holgate ST. Inhaled adenosine and guanosine on airway resistance in normal and asthmatic subjects. *Br J Clin Pharmacol* 2004;**58**:S751–S755.
125. Burki NK, Alam M, Lee L-Y. The pulmonary effects of intravenous adenosine in asthmatic subjects. *Respiratory Research* 2006;**7**:139–139.
126. Burkhart KK. Respiratory failure following adenosine administration. *Am J Emerg Med* 1993;**11**:249–250.
127. DeGross CG, Silka MJ. Bronchospasm after intravenous administration of adenosine in a patient with asthma. *J Pediatr* 1994;**125**:822–823.
128. Brubaker S, Long B, Koefman A. Alternative treatment options for atrioventricular-nodal-reentry tachycardia: an emergency medicine review. *J Emerg Med* 2018;**54**:198–206.
129. Stambler BS, Dorian P, Sager PT, Wight D, Douville P, Potvin D, Shamsad P, Haberman RJ, Kuk RS, Lakkireddy DR, Teixeira JM, Bilchick KC, Damle RS, Bernstein RC, Lam WW, O'Neill G, Noseworthy PA, Venkatchalam KL, Couto B, Mondesert B, Plat F. Etipamil nasal spray for rapid conversion of supraventricular tachycardia to sinus rhythm. *J Am Coll Cardiol* 2018;**72**:489–497.
130. Olasveengen TM, de Caen AR, Mancini ME, Maconochie IK, Aickin R, Atkins DL, Berg RA, Bingham RM, Brooks SC, Castrén M, Chung SP, Considine J, Couto TB, Escalante R, Gazmuri RJ, Guerguerian AM, Hatanaka T, Koster RW, Kudenchuk PJ, Lang E, Lim SH, Løfgren B, Meaney PA, Montgomery WH, Morley PT, Morrison LJ, Nation KJ, Ng KC, Nadkarni VM, Nishiyama C, Nuthall G, Ong GY, Perkins GD, Reis AG, Ristagno G, Sakamoto T, Sayre MR, Schexnayder SM, Sierra AF, Singletary EM, Shimizu N, Smyth MA, Stanton D, Tijssen JA, Travers A, Vaillancourt C, Van de Voorde P, Hazinski MF, Nolan JP, ILCOR Collaborators. 2017 international consensus on cardiopulmonary resuscitation and emergency cardiovascular care science with treatment recommendations summary. *Circulation* 2017;**136**:e424–e440.
131. Priori SG, Blomström-Lundqvist C, Mazzanti A, Blom N, Borggrefe M, Camm J, Elliott PM, Fitzsimons D, Hatala R, Hindricks G, Kirchhoff P, Kjeldsen K, Kuck KH, Hernandez-Madrid A, Nikolaou N, Norekvål TM, Spaulding C, Van Veldhuisen DJ, Kolh P, Lip GYH, Agewall S, Barón-Esquivias G, Boriani G, Budts W, Bueno H, Capodanno D, Carerj S, Crespo-Leiro MG, Czerny M, Deaton C, Dobrev D, Erol C, Galderisi M, Gorenek B, Kriebel T, Lambiase P, Lancellotti P, Lane DA, Lang I, Manolis AJ, Morais J, Moreno J, Piepoli MF, Rutten FH, Sredniawa B, Zamorano JL, Zannad F. 2015 ESC Guidelines for the management of patients with ventricular arrhythmias and the prevention of sudden cardiac death. The Task Force for the Management of Patients with Ventricular Arrhythmias and the Prevention of Sudden Cardiac Death of the European Society of Cardiology (ESC) Endorsed by: Association for European Paediatric and Congenital Cardiology (AEPC). *Eur Heart J* 2015;**36**:2793–2867.
132. Ortiz M, Martin A, Arribas F, Coll-Vinent B, Del Arco C, Peinado R, Almendral J; PROCAMIO Study Investigators. Randomized comparison of intravenous procainamide vs. intravenous amiodarone for the acute treatment of tolerated wide QRS tachycardia: the PROCAMIO study. *Eur Heart J* 2017;**38**:1329–1335.
133. Buxton AE, Marchlinski FE, Doherty JU, Flores B, Josephson ME. Hazards of intravenous verapamil for sustained ventricular tachycardia. *Am J Cardiol* 1987;**59**:1107–1110.
134. Dancy M, Camm AJ, Ward D. Misdiagnosis of chronic recurrent ventricular tachycardia. *Lancet* 1985;**326**:320–323.
135. Crijns HJ, Lie KI. Haemodynamic deterioration after treatment with adenosine. *Br Heart J* 1995;**73**:103.
136. Gorgels APM, van den Dool A, Hofs A, Mulleneers R, Smeets JLRM, Vos MA, Wellens HJJ. Comparison of procainamide and lidocaine in terminating sustained monomorphic ventricular tachycardia. *Am J Cardiol* 1996;**78**:43–46.
137. Scheinman MM, Levine JH, Cannon DS, Friehling T, Kopelman HA, Chilson DA, Platia EV, Wilber DJ, Kowey PR. Dose-ranging study of intravenous amiodarone in patients with life-threatening ventricular tachyarrhythmias. *Circulation* 1995;**92**:3264–3272.
138. Levine JH, Massumi A, Scheinman MM, Winkle RA, Platia EV, Chilson DA, Gomes JA, Woosley RL. Intravenous amiodarone for recurrent sustained hypotensive ventricular tachyarrhythmias. *J Am Coll Cardiol* 1996;**27**:67–75.
139. Olshansky B, Sullivan RM. Inappropriate sinus tachycardia. *Europace* 2019;**21**:194–207.
140. Still A-M, Raatikainen P, Ylitalo A, Kauma H, Ikäheimo M, Kesäniemi YA, Huikuri HV. Prevalence, characteristics and natural course of inappropriate sinus tachycardia. *Europace* 2005;**7**:104–112.

141. Baruscotti M, Bucchi A, Milanese R, Paina M, Barbuti A, Gnecci-Ruscione T, Bianco E, Vitali-Serdoz L, Cappato R, DiFrancesco D. A gain-of-function mutation in the cardiac pacemaker HCN4 channel increasing cAMP sensitivity is associated with familial Inappropriate Sinus Tachycardia. *Eur Heart J* 2017;**38**:280–288.
142. Ruzieh M, Moustafa A, Sabbagh E, Karim MM, Karim S. Challenges in treatment of inappropriate sinus tachycardia. *Curr Cardiol Rev* 2018;**14**:42–44.
143. Brunner S, Herbel R, Droblesch C, Peters A, Massberg S, Kaab S, Sinner MF. Alcohol consumption, sinus tachycardia, and cardiac arrhythmias at the Munich Oktoberfest: results from the Munich Beer Related Electrocardiogram Workup Study (MunichBREW). *Eur Heart J* 2017;**38**:2100–2106.
144. Shen WK. How to manage patients with inappropriate sinus tachycardia. *Heart Rhythm* 2005;**2**:1015–1019.
145. Foster MC, Levine PA. Use of verapamil to control an inappropriate chronic sinus tachycardia. *Chest* 1984;**85**:697–699.
146. Cappato R, Castelvécchio S, Ricci C, Bianco E, Vitali-Serdoz L, Gnecci-Ruscione T, Pittalis M, De Ambroggi L, Baruscotti M, Gaeta M, Furlanello F, Di Francesco D, Lupo PP. Clinical efficacy of ivabradine in patients with inappropriate sinus tachycardia: a prospective, randomized, placebo-controlled, double-blind, crossover evaluation. *J Am Coll Cardiol* 2012;**60**:1323–1329.
147. Ptaszynski P, Kaczmarek K, Ruta J, Klingenheben T, Wranicz JK. Metoprolol succinate vs. ivabradine in the treatment of inappropriate sinus tachycardia in patients unresponsive to previous pharmacological therapy. *Europace* 2013;**15**:116–121.
148. Benezet-Mazuecos J, Rubio JM, Farré J, Quiñones MÁ, Sanchez-Borque P, MacIÀ E. Long-term outcomes of ivabradine in inappropriate sinus tachycardia patients: appropriate efficacy or inappropriate patients. *Pacing Clin Electrophysiol* 2013;**36**:830–836.
149. Calò L, Rebecchi M, Sette A, Martino A, de Ruvo E, Sciarra L, De Luca L, Zuccaro LM, Giunta G, Ciccagliani A, Lioy E, Fedele F. Efficacy of ivabradine administration in patients affected by inappropriate sinus tachycardia. *Heart Rhythm* 2010;**7**:1318–1323.
150. Ptaszynski P, Kaczmarek K, Ruta J, Klingenheben T, Wranicz JK. Ivabradine in the treatment of inappropriate sinus tachycardia in patients after successful radiofrequency catheter ablation of atrioventricular node slow pathway. *Pacing Clin Electrophysiol* 2013;**36**:42–49.
151. Dias da Silva VJ, Tobaldini E, Rocchetti M, Wu MA, Malfatto G, Montano N, Zaza A. Modulation of sympathetic activity and heart rate variability by ivabradine. *Cardiovasc Res* 2015;**108**:31–38.
152. Ptaszynski P, Kaczmarek K, Ruta J, Klingenheben T, Cygankiewicz I, Wranicz JK. Ivabradine in combination with metoprolol succinate in the treatment of inappropriate sinus tachycardia. *J Cardiovasc Pharmacol Ther* 2013;**18**:338–344.
153. Regitz-Zagrosek V, Roos-Hesslink JW, Bauersachs J, Blomström-Lundqvist C, Cifková R, De Bonis M, Iung B, Johnson MR, Kintscher U, Kranke P, Lang IM, Morais J, Pieper PG, Presbitero P, Price S, Rosano GMC, Seeland U, Simoncini T, Swan L, Warnes CA; ESC Scientific Document Group. 2018 ESC Guidelines for the management of cardiovascular diseases during pregnancy. *Eur Heart J* 2018;**39**:3165–3241.
154. Yu J, Zhou Z, Tay-Sontheimer J, Levy RH, Ragueneau-Majlessi I. Risk of clinically relevant pharmacokinetic-based drug-drug interactions with drugs approved by the U.S. Food and Drug Administration between 2013 and 2016. *Drug Metab Dispos* 2018;**46**:835–845.
155. Man KC, Knight B, Tse H-F, Pelosi F, Michaud GF, Flemming M, Strickberger SA, Morady F. Radiofrequency catheter ablation of inappropriate sinus tachycardia guided by activation mapping. *J Am Coll Cardiol* 2000;**35**:451–457.
156. Marrouche NF, Beheiry S, Tomassoni G, Cole C, Bash D, Dresing T, Saliba W, Abdul-Karim A, Tchou P, Schweikert R, Leonelli F, Natale A. Three-dimensional nonfluoroscopic mapping and ablation of inappropriate sinus tachycardia: procedural strategies and long-term outcome. *J Am Coll Cardiol* 2002;**39**:1046–1054.
157. Callans DJ, Ren J-F, Schwartzman D, Gottlieb CD, Chaudhry FA, Marchlinski FE. Narrowing of the superior vena cava–right atrium junction during radiofrequency catheter ablation for inappropriate sinus tachycardia: analysis with intracardiac echocardiography. *J Am Coll Cardiol* 1999;**33**:1667–1670.
158. Takemoto M, Mukai Y, Inoue S, Matoba T, Nishizaka M, Ide T, Chishaki A, Sunagawa K. Usefulness of non-contact mapping for radiofrequency catheter ablation of inappropriate sinus tachycardia: new procedural strategy and long-term clinical outcome. *Intern Med* 2012;**51**:357–362.
159. Koplan BA, Parkash R, Couper G, Stevenson WG. Combined epicardial-endocardial approach to ablation of inappropriate sinus tachycardia. *J Cardiovasc Electrophysiol* 2004;**15**:237–240.
160. Jacobson JT, Kraus A, Lee R, Goldberger JJ. Epicardial/endocardial sinus node ablation after failed endocardial ablation for the treatment of inappropriate sinus tachycardia. *J Cardiovasc Electrophysiol* 2014;**25**:236–241.
161. Rodríguez-Mañero M, Kreidieh B, Al Rifai M, Ibarra-Cortez S, Schurmann P, Álvarez PA, Fernández-López XA, García-Seara J, Martínez-Sande L, González-Juanatey JR, Valderrábano M. Ablation of inappropriate sinus tachycardia: a systematic review of the literature. *JACC Clin Electrophysiol* 2017;**3**:253–265.
162. Klein I, Ojamaa K. Thyroid hormone and the cardiovascular system. *N Engl J Med* 2001;**344**:501–509.
163. Gomes JA, Hariman RJ, Kang PS, Chowdry IH. Sustained symptomatic sinus node reentrant tachycardia: Incidence, clinical significance, electrophysiologic observations and the effects of antiarrhythmic agents. *J Am Coll Cardiol* 1985;**5**:45–57.
164. Malik AK, Ching CK, Liew R, Chong DT, Teo WS. Successful ablation of sinus node reentrant tachycardia using remote magnetic navigation system. *Europace* 2012;**14**:455–456.
165. Cossu SF, Steinberg JS. Supraventricular tachyarrhythmias involving the sinus node: clinical and electrophysiologic characteristics. *Prog Cardiovasc Dis* 1998;**41**:51–63.
166. Sanders WE Jr, Sorrentino RA, Greenfield RA, Shenasa H, Hamer ME, Wharton JM. Catheter ablation of sinoatrial node reentrant tachycardia. *J Am Coll Cardiol* 1994;**23**:926–934.
167. Fu Q, VanGundy TB, Shibata S, Auchus RJ, Williams GH, Levine BD. Exercise training versus propranolol in the treatment of the postural orthostatic tachycardia syndrome. *Hypertension* 2011;**58**:167–175.
168. Fu Q, VanGundy TB, Galbreath MM, Shibata S, Jain M, Hastings JL, Bhella PS, Levine BD. Cardiac origins of the postural orthostatic tachycardia syndrome. *J Am Coll Cardiol* 2010;**55**:2858–2868.
169. Winker R, Barth A, Bidmon D, Ponocny I, Weber M, Mayr O, Robertson D, Diedrich A, Maier R, Pilger A, Haber P, Rüdiger HW. Endurance exercise training in orthostatic intolerance. A randomized, controlled trial 2005;**45**:391–398.
170. Jacob G, Shannon JR, Black B, Biaggioni I, Mosqueda-Garcia R, Robertson RM, Robertson D. Effects of volume loading and pressor agents in idiopathic orthostatic tachycardia. *Circulation* 1997;**96**:575–580.
171. Raj SR, Biaggioni I, Yamhure PC, Black BK, Paranjape SY, Byrne DW, Robertson D. Renin-aldosterone paradox and perturbed blood volume regulation underlying postural tachycardia syndrome. *Circulation* 2005;**111**:1574–1582.
172. Raj SR, Black BK, Biaggioni I, Paranjape SY, Ramirez M, Dupont WD, Robertson D. Propranolol decreases tachycardia and improves symptoms in the postural tachycardia syndrome. Less is more. *Circulation* 2009;**120**:725–734.
173. Kanjwal K, Karabin B, Sheikh M, Elmer L, Kanjwal Y, Saeed B, Grubb BP. Pyridostigmine in the treatment of postural orthostatic tachycardia: A single-center experience. *Pacing Clin Electrophysiol* 2011;**34**:750–755.
174. Raj SR, Black BK, Biaggioni I, Harris PA, Robertson D. Acetylcholinesterase inhibition improves tachycardia in postural tachycardia syndrome. *Circulation* 2005;**111**:2734–2740.
175. McDonald C, Frith J, Newton JL. Single centre experience of ivabradine in postural orthostatic tachycardia syndrome. *Europace* 2011;**13**:427–430.
176. Glukhov AV, Hage LT, Hansen BJ, Pedraza-Toscano A, Vargas-Pinto P, Hamlin RL, Weiss R, Carnes CA, Billman GE, Fedorov VV. Sinoatrial node reentry in a canine chronic left ventricular infarct model: role of intranodal fibrosis and heterogeneity of refractoriness. *Circ Arrhythm Electrophysiol* 2013;**6**:984–994.
177. Sheldon RS, Grubb BP, Olshansky B, Shen W-K, Calkins H, Brignole M, Raj SR, Krahn AD, Morillo CA, Stewart JM, Sutton R, Sandroni P, Friday KJ, Hachul DT, Cohen MI, Lau DH, Mayuga KA, Moak JP, Sandhu RK, Kanjwal K. 2015 Heart Rhythm Society expert consensus statement on the diagnosis and treatment of postural tachycardia syndrome, inappropriate sinus tachycardia, and vasovagal syncope. *Heart Rhythm* 2015;**12**:e41–e63.
178. Bryarly M, Phillips LT, Fu Q, Vernino S, Levine BD. Postural orthostatic tachycardia syndrome: JACC Focus Seminar. *J Am Coll Cardiol* 2019;**73**:1207–1228.
179. Benarroch EE. Postural tachycardia syndrome: a heterogeneous and multifactorial disorder. *Mayo Clinic Proceedings* 2012;**87**:1214–1225.
180. Tomichi Y, Kawano H, Mukaino A, Chiba A, Doi Y, Arakawa S, Ishimatsu T, Fukae S, Abiru N, Maemura K. Postural orthostatic tachycardia in a patient with type 2 diabetes with diabetic neuropathy. *Int Heart J* 2018;**59**:1488–1490.
181. Low PA, Sandroni P, Joyner M, Shen WK. Postural tachycardia syndrome (POTS). *J Cardiovasc Electrophysiol* 2009;**20**:352–358.
182. Fedorowski A. Postural orthostatic tachycardia syndrome: clinical presentation, aetiology, and management. *J Intern Med* 2018;**285**:352–366.
183. Poutiainen AM, Koistinen MJ, Airaksinen KE, Hartikainen EK, Kettunen RVJ, Karjalainen JE, Huikuri HV. Prevalence and natural course of ectopic atrial tachycardia. *Eur Heart J* 1999;**20**:694–700.
184. Kistler PM, Sanders P, Fynn SP, Stevenson IH, Hussin A, Vohra JK, Sparks PB, Kalman JM. Electrophysiological and electrocardiographic characteristics of focal atrial tachycardia originating from the pulmonary veins: acute and long-term outcomes of radiofrequency ablation. *Circulation* 2003;**108**:1968–1975.
185. Haissaguerre M, Jais P, Shah DC, Takahashi A, Hocini M, Quiniou G, Garrigue S, Le Mouroux A, Le Metayer P, Clementy J. Spontaneous initiation of atrial fibrillation by ectopic beats originating in the pulmonary veins. *N Engl J Med* 1998;**339**:659–666.

186. Kistler PM, Roberts-Thomson KC, Haqqani HM, Fynn SP, Singarayar S, Vohra JK, Morton JB, Sparks PB, Kalman JM. P-wave morphology in focal atrial tachycardia: development of an algorithm to predict the anatomic site of origin. *J Am Coll Cardiol* 2006;**48**:1010–1017.
187. Chen SA, Chiang CE, Yang CJ, Cheng CC, Wu TJ, Wang SP, Chiang BN, Chang MS. Sustained atrial tachycardia in adult patients. Electrophysiological characteristics, pharmacological response, possible mechanisms, and effects of radiofrequency ablation. *Circulation* 1994;**90**:1262–1278.
188. Mehta AV, Sanchez GR, Sacks EJ, Casta A, Dunn JM, Donner RM. Ectopic automatic atrial tachycardia in children: clinical characteristics, management and follow-up. *J Am Coll Cardiol* 1988;**11**:379–385.
189. Hohnloser SH, Zabel M. Short- and long-term efficacy and safety of flecainide acetate for supraventricular arrhythmias. *Am J Cardiol* 1992;**70**:A3–A10.
190. Kunze K-P, Kuck K-H, Schlüter M, Bleifeld W. Effect of encainide and flecainide on chronic ectopic atrial tachycardia. *J Am Coll Cardiol* 1986;**7**:1121–1126.
191. Eidher U, Freihoff F, Kaltenbrunner W, Steinbach K. Efficacy and safety of ibutilide for the conversion of monomorphic atrial tachycardia. *Pacing Clin Electrophysiol* 2006;**29**:358–362.
192. Vietti-Ramus G, Veglio F, Marchisio U, Burzio P, Latini R. Efficacy and safety of short intravenous amiodarone in supraventricular tachyarrhythmias. *Int J Cardiol* 1992;**35**:77–85.
193. Salem JE, Dureau P, Funck-Brentano C, Hulot JS, El-Aissoumi M, Aissoumi N, Urien S, Faisy C. Effectiveness of heart rate control on hemodynamics in critically ill patients with atrial tachyarrhythmias managed by amiodarone. *Pharmacol Res* 2017;**122**:118–126.
194. Anguera I, Brugada J, Roba M, Mont Ls, Aguinaga L, Geelen P, Brugada P. Outcomes after radiofrequency catheter ablation of atrial tachycardia. *Am J Cardiol* 2001;**87**:886–890.
195. Biviano AB, Bain W, Whang W, Leitner J, Dizon J, Hickey K, Garan H. Focal left atrial tachycardias not associated with prior catheter ablation for atrial fibrillation: clinical and electrophysiological characteristics. *Pacing Clin Electrophysiol* 2012;**35**:17–27.
196. Medi C, Kalman JM, Haqqani H, Vohra JK, Morton JB, Sparks PB, Kistler PM. Tachycardia-mediated cardiomyopathy secondary to focal atrial tachycardia: long-term outcome after catheter ablation. *J Am Coll Cardiol* 2009;**53**:1791–1797.
197. Ouyang F, Ma J, Ho SY, Bänsch D, Schmidt B, Ernst S, Kuck K-H, Liu S, Huang H, Chen M, Chun J, Xia Y, Satomi K, Chu H, Zhang S, Antz M. Focal atrial tachycardia originating from the non-coronary aortic sinus: electrophysiological characteristics and catheter ablation. *J Am Coll Cardiol* 2006;**48**:122–131.
198. Heusch A, Kramer HH, Krogmann ON, Rammos S, Bourgeois M. Clinical experience with propafenone for cardiac arrhythmias in the young. *Eur Heart J* 1994;**15**:1050–1056.
199. Meles E, Carbone C, Maggolini S, Moretti P, CC DECGentile G, Gnecciruscone T. A case of atrial tachycardia treated with ivabradine as bridge to ablation. *J Cardiovasc Electrophysiol* 2015;**26**:565–568.
200. Bohora S, Lokhandwala Y, Parekh P, Vasavda A. Reversal of tachycardiomyopathy due to left atrial tachycardia by ivabradine. *J Cardiovasc Electrophysiol* 2011;**22**:340–342.
201. Guccione P, Paul T, Garson A Jr. Long-term follow-up of amiodarone therapy in the young: continued efficacy, unimpaired growth, moderate side effects. *J Am Coll Cardiol* 1990;**15**:1118–1124.
202. von Bernuth G, Engelhardt W, Kramer HH, Singer H, Schneider P, Ulmer H, Brodherr-Heberlein S, Kienast W, Lang D, Lindinger A, Schmidt K. Atrial automatic tachycardia in infancy and childhood. *Eur Heart J* 1992;**13**:1410–1415.
203. Spector P, Reynolds MR, Calkins H, Sondhi M, Xu Y, Martin A, Williams CJ, Sledge I. Meta-analysis of ablation of atrial flutter and supraventricular tachycardia. *Am J Cardiol* 2009;**104**:671–677.
204. Bohnen M, Stevenson WG, Tedrow UB, Michaud GF, John RM, Epstein LM, Albert CM, Koplan BA. Incidence and predictors of major complications from contemporary catheter ablation to treat cardiac arrhythmias. *Heart Rhythm* 2011;**8**:1661–1666.
205. Keegan R, Aguinaga L, Fenelon G, Uribe W, Rodriguez Diez G, Scanavacca M, Patete M, Carhuaz RZ, Labadet C, De Zuloaga C, Pozzer D, Scazzuso F. The first Latin American Catheter Ablation Registry. *Europace* 2015;**17**:794–800.
206. Steinbeck G, Sinner MF, Lutz M, Muller-Nurasyid M, Kaab S, Reinecke H. Incidence of complications related to catheter ablation of atrial fibrillation and atrial flutter: a nationwide in-hospital analysis of administrative data for Germany in 2014. *Eur Heart J* 2018;**39**:4020–4029.
207. König S, Ueberham L, Schuler E, Wiedemann M, Reithmann C, Seyfarth M, Sause A, Tebbenjohanns J, Schade A, Shin DI, Staudt A, Zacharzowsky U, Andrie R, Wetzler U, Neuser H, Wunderlich C, Kuhlen R, Tijssen JGP, Hindricks G, Bollmann A. In-hospital mortality of patients with atrial arrhythmias: insights from the German-wide Helios hospital network of 161 502 patients and 34 025 arrhythmia-related procedures. *Eur Heart J* 2018;**39**:3947–3957.
208. Katritsis DG, Zografos T, Siontis KC, Giannopoulos G, Muthalaly RG, Liu Q, Latchamsetty R, Varga Z, Deftereos S, Swerdlow C, Callans DJ, Miller JM, Morady F, John RM, Stevenson WG. End-points for successful slow pathway catheter ablation in typical and atypical atrioventricular nodal reentrant tachycardia: a contemporary, multicenter study. *JACC Clin Electrophysiol* 2019;**5**:113–119.
209. Kastor JA. Multifocal atrial tachycardia. *N Engl J Med* 1990;**322**:1713–1717.
210. Bradley DJ, Fischbach PS, Law IH, Serwer GA, Dick M II. The clinical course of multifocal atrial tachycardia in infants and children. *J Am Coll Cardiol* 2001;**38**:401–408.
211. Iseri LT, Fairshter RD, Hardemann JL, Brodsky MA. Magnesium and potassium therapy in multifocal atrial tachycardia. *Am Heart J* 1985;**110**:789–794.
212. Marchlinski FE, Miller JM. Atrial arrhythmias exacerbated by theophylline: response to verapamil and evidence for triggered activity in man. *Chest* 1985;**88**:931–934.
213. Salerno DM, Anderson B, Sharkey PJ, Iber C. Intravenous verapamil for treatment of multifocal atrial tachycardia with and without calcium pretreatment. *Ann Intern Med* 1987;**107**:623–628.
214. Arsur E, Lefkin AS, Scher DL, Solar M, Tessler S. A randomized, double-blind, placebo-controlled study of verapamil and metoprolol in treatment of multifocal atrial tachycardia. *Am J Med* 1988;**85**:519–524.
215. Pierce WJ, McGroarty K. Multifocal atrial tachycardia and Ibutilide. *Am J Geriatr Cardiol* 2001;**10**:193–195.
216. Ueng KC, Lee SH, Wu DJ, Lin CS, Chang MS, Chen SA. Radiofrequency catheter modification of atrioventricular junction in patients with COPD and medically refractory multifocal atrial tachycardia. *Chest* 2000;**117**:52–59.
217. Hazard PB, Burnett CR. Verapamil in multifocal atrial tachycardia: hemodynamic and respiratory changes. *Chest* 1987;**91**:68–70.
218. Levine JH, Michael JR, Guarnieri T. Treatment of multifocal atrial tachycardia with verapamil. *N Engl J Med* 1985;**312**:21–25.
219. Hazard PB, Burnett CR. Treatment of multifocal atrial tachycardia with metoprolol. *Crit Care Med* 1987;**15**:20–25.
220. Saoudi N, Cosio F, Waldo A, Chen S-A, Iesaka Y, Lesh M, Saksena S, Salerno J, Schoels W. Classification of atrial flutter and regular atrial tachycardia according to electrophysiologic mechanism and anatomic bases: a statement from a joint expert group from the Working Group of Arrhythmias of the European Society of Cardiology and the North American Society of Pacing and Electrophysiology. *J Cardiovasc Electrophysiol* 2001;**12**:852–866.
221. Saoudi N, Nair M, Abdelazziz A, Poty H, Daou A, Anselme F, Letac B. Electrocardiographic patterns and results of radiofrequency catheter ablation of clockwise type I atrial flutter. *J Cardiovasc Electrophysiol* 1996;**7**:931–942.
222. Olgin JE, Kalman JM, Fitzpatrick AP, Lesh MD. Role of right atrial endocardial structures as barriers to conduction during human type I atrial flutter. Activation and entrainment mapping guided by intracardiac echocardiography. *Circulation* 1995;**92**:1839–1848.
223. Chugh A, Latchamsetty R, Oral H, Elmouchi D, Tschopp D, Reich S, Igic P, Lemerand T, Good E, Bogun F, Pelosi F Jr, Morady F. Characteristics of cavotricuspid isthmus-dependent atrial flutter after left atrial ablation of atrial fibrillation. *Circulation* 2006;**113**:609–615.
224. Stevenson IH, Kistler PM, Spence SJ, Vohra JK, Sparks PB, Morton JB, Kalman JM. Scar-related right atrial macroreentrant tachycardia in patients without prior atrial surgery: electroanatomic characterization and ablation outcome. *Heart Rhythm* 2005;**2**:594–601.
225. Havránek S, Simek J, Stovicek P, Wichterle D. Distribution of mean cycle length in cavo-tricuspid isthmus dependent atrial flutter. *Physiol Res* 2012;**61**:43–51.
226. Barbato G, Carinci V, Tomasi C, Frassinetti V, Margheri M, Di Pasquale G. Is electrocardiography a reliable tool for identifying patients with isthmus-dependent atrial flutter? *Europace* 2009;**11**:1071–1076.
227. Halligan SC, Gersh BJ, Brown RD Jr, Rosales AG, Munger TM, Shen WK, Hammill SC, Friedman PA. The natural history of lone atrial flutter. *Ann Intern Med* 2004;**140**:265–268.
228. Chinitz JS, Gerstenfeld EP, Marchlinski FE, Callans DJ. Atrial fibrillation is common after ablation of isolated atrial flutter during long-term follow-up. *Heart Rhythm* 2007;**4**:1029–1033.
229. Pérez FJ, Schubert CM, Parvez B, Pathak V, Ellenbogen KA, Wood MA. Long-term outcomes after catheter ablation of cavo-tricuspid isthmus dependent atrial flutter. A meta-analysis. *Circ Arrhythm Electrophysiol* 2009;**3**:393–401.
230. Reithmann C, Hoffmann E, Spitzlberger G, Dorwarth U, Gerth A, Remp T, Steinbeck G. Catheter ablation of atrial flutter due to amiodarone therapy for paroxysmal atrial fibrillation. *Eur Heart J* 2000;**21**:565–572.
231. Bertaglia E, Bonso A, Zoppo F, Proclemer A, Verlatto R, Corò L, Mantovan R, Themistoclakis S, Raviele A, Pascotto P. Different clinical courses and predictors of atrial fibrillation occurrence after transisthmus ablation in patients with preablation lone atrial flutter, coexistent atrial fibrillation, and drug induced atrial flutter. *Pacing Clin Electrophysiol* 2004;**27**:1507–1512.
232. Nabar A, Rodriguez LM, Timmermans C, van Mechelen R, Wellens HJJ. Class IC antiarrhythmic drug induced atrial flutter: electrocardiographic and

- electrophysiological findings and their importance for long term outcome after right atrial isthmus ablation. *Heart* 2001;**85**:424–429.
233. Luchsinger JA, Steinberg JS. Resolution of cardiomyopathy after ablation of atrial flutter. *J Am Coll Cardiol* 1998;**32**:205–210.
 234. Pizzale S, Lemery R, Green MS, Gollob MH, Tang ASL, Birnie DH. Frequency and predictors of tachycardia-induced cardiomyopathy in patients with persistent atrial flutter. *Can J Cardiol* 2009;**25**:469–472.
 235. Ellenbogen KA, Dias VC, Cardello FP, Strauss WE, Simonton CA, Pollak SJ, Wood MA, Stambler BS. Safety and efficacy of intravenous diltiazem in atrial fibrillation or atrial flutter. *Am J Cardiol* 1995;**75**:45–49.
 236. Salerno DM, Dias VC, Kleiger RE, Tschida VH, Sung RJ, Sami M, Giorgi LV. Efficacy and safety of intravenous diltiazem for treatment of atrial fibrillation and atrial flutter. *Am J Cardiol* 1989;**63**:1046–1051.
 237. Platia EV, Michelson EL, Porterfield JK, Das G. Esmolol versus verapamil in the acute treatment of atrial fibrillation or atrial flutter. *Am J Cardiol* 1989;**63**:925–929.
 238. Ellenbogen KA, Dias VC, Plumb VJ, Heywood JT, Mirvis DM. A placebo-controlled trial of continuous intravenous diltiazem infusion for 24-hour heart rate control during atrial fibrillation and atrial flutter: a multicenter study. *J Am Coll Cardiol* 1991;**18**:891–897.
 239. Delle Karth G, Geppert A, Neunteufl T, Priglinger U, Haumer M, Gschwandner M, Siostrzonek P, Heinz G. Amiodarone versus diltiazem for rate control in critically ill patients with atrial tachyarrhythmias. *Crit Care Med* 2001;**29**:1149–1153.
 240. Clemo HF, Wood MA, Gilligan DM, Ellenbogen KA. Intravenous amiodarone for acute heart rate control in the critically ill patient with atrial tachyarrhythmias. *Am J Cardiol* 1998;**81**:594–598.
 241. Ghali WA, Wasil BI, Brant R, Exner DV, Cornuz J. Atrial flutter and the risk of thromboembolism: a systematic review and meta-analysis. *Am J Med* 2005;**118**:101–107.
 242. Vadmann H, Nielsen PB, Hjortshøj SP, Riahi S, Rasmussen LH, Lip GYH, Larsen TB. Atrial flutter and thromboembolic risk: a systematic review. *Heart* 2015;**101**:1446–1455.
 243. Seidl K, Hauer B, Schwick NG, Zellner D, Zahn R, Senges J. Risk of thromboembolic events in patients with atrial flutter. *Am J Cardiol* 1998;**82**:580–583.
 244. Wood KA, Eisenberg SJ, Kalman JM, Drew BJ, Saxon LA, Lee RJ, Lesh MD, Scheinman MM. Risk of thromboembolism in chronic atrial flutter. *Am J Cardiol* 1997;**79**:1043–1047.
 245. Lin YS, Chen YL, Chen TH, Lin MS, Liu CH, Yang TY, Chung CM, Chen MC. Comparison of clinical outcomes among patients with atrial fibrillation or atrial flutter stratified by CHA2DS2-VASc score. *JAMA Netw Open* 2018;**1**:e180941.
 246. Chen YL, Lin YS, Wang HT, Liu WH, Chen HC, Chen MC. Clinical outcomes of solitary atrial flutter patients using anticoagulation therapy: a national cohort study. *Europace* 2019;**21**:313–321.
 247. Schmidt H, von der Recke G, Illien S, Lewalter T, Schimpf R, Wolpert C, Becher H, Lüderitz B, Omran H. Prevalence of left atrial chamber and appendage thrombi in patients with atrial flutter and its clinical significance. *J Am Coll Cardiol* 2001;**38**:778–784.
 248. Gallagher MM, Guo X-H, Poloniecki JD, Guan Yap Y, Ward D, Camm AJ. Initial energy setting, outcome and efficiency in direct current cardioversion of atrial fibrillation and flutter. *J Am Coll Cardiol* 2001;**38**:1498–1504.
 249. Van Gelder IC, Crijns HJ, Van Gilst WH, Verwer R, Lie KI. Prediction of uneventful cardioversion and maintenance of sinus rhythm from direct-current electrical cardioversion of chronic atrial fibrillation and flutter. *Am J Cardiol* 1991;**68**:41–46.
 250. Crijns HJGM, Van Gelder IC, Kingma JH, Dunselman PHJM, Gosselink ATM, Lie KI. Atrial flutter can be terminated by a class III antiarrhythmic drug but not by a class IC drug. *Eur Heart J* 1994;**15**:1403–1408.
 251. Stambler BS, Wood MA, Ellenbogen KA, Perry KT, Wakefield LK, Vanderlugt JT. Efficacy and safety of repeated intravenous doses of ibutilide for rapid conversion of atrial flutter or fibrillation. *Circulation* 1996;**94**:1613–1621.
 252. Ellenbogen KA, Stambler BS, Wood MA, Sager PT, Wesley RC, Meissner MD, Zoble RG, Wakefield LK, Perry KT, Vanderlugt JT, Ibutilide I. Efficacy of intravenous ibutilide for rapid termination of atrial fibrillation and atrial flutter: a dose-response study. *J Am Coll Cardiol* 1996;**28**:130–136.
 253. Falk MDRFH, Pollak MDA, Singh MDFS, Friedrich MDT. Intravenous dofetilide, a class III antiarrhythmic agent, for the termination of sustained atrial fibrillation or flutter. *J Am Coll Cardiol* 1997;**29**:385–390.
 254. Stambler BS, Wood MA, Ellenbogen KA. Antiarrhythmic actions of intravenous ibutilide compared with procainamide during human atrial flutter and fibrillation: electrophysiological determinants of enhanced conversion efficacy. *Circulation* 1997;**96**:4298–4306.
 255. Volgman AS, Carberry PA, Stambler B, Lewis WR, Dunn GH, Perry KT, Vanderlugt JT, Kowey PR. Conversion efficacy and safety of intravenous ibutilide compared with intravenous procainamide in patients with atrial flutter or fibrillation. *J Am Coll Cardiol* 1998;**31**:1414–1419.
 256. Vos MA, Golitsyn SR, Stangl K, Ruda MY, Van Wijk L, Harry JD, Perry KT, Touboul P, Steinbeck G, Wellens HJJ. Superiority of ibutilide (a new class III agent) over dl-sotalol in converting atrial flutter and atrial fibrillation. *Heart* 1998;**79**:568–575.
 257. Singh S, Zoble RG, Yellen L, Brodsky MA, Feld GK, Berk M, Billing CB. Efficacy and safety of oral dofetilide in converting to and maintaining sinus rhythm in patients with chronic atrial fibrillation or atrial flutter. *The Symptomatic Atrial Fibrillation Investigative Research on Dofetilide (SAFIRE-D) study* 2000;**102**:2385–2390.
 258. Peters RW, Shorofsky SR, Pelini M, Olsovsky M, Gold MR. Overdrive atrial pacing for conversion of atrial flutter: comparison of postoperative with nonpostoperative patients. *Am Heart J* 1999;**137**:100–103.
 259. Gillis AM, Unterberg-Buchwald C, Schmidinger H, Massimo S, Wolfe K, Kavaney DJ, Otterness MF, Hohnloser SH. Safety and efficacy of advanced atrial pacing therapies for atrial tachyarrhythmias in patients with a new implantable dual chamber cardioverter-defibrillator. *J Am Coll Cardiol* 2002;**40**:1653–1659.
 260. Mitchell AR, Spurrell PA, Cheatle L, Sulke N. Effect of atrial antitachycardia pacing treatments in patients with an atrial defibrillator: randomised study comparing subthreshold and nominal pacing outputs. *Heart* 2002;**87**:433–437.
 261. Rhodes LA, Walsh EP, Saul JP. Conversion of atrial flutter in pediatric patients by transesophageal atrial pacing: a safe, effective, minimally invasive procedure. *Am Heart J* 1995;**130**:323–327.
 262. Natale A, Newby KH, Pisanó E, Leonelli F, Fanelli R, Potenza D, Beheiry S, Tomassoni G. Prospective randomized comparison of antiarrhythmic therapy versus first-line radiofrequency ablation in patients with atrial flutter. *J Am Coll Cardiol* 2000;**35**:1898–1904.
 263. Da Costa A, Thévenin J, Roche F, Romeyer-Bouchard C, Abdellouli L, Messier M, Denis L, Faure E, Gonthier R, Kruszynski G, Pages JM, Bonijoly S, Lamaison D, Defaye P, Barthélemy JC, Gouttard T, Isaz K. Results from the Loire-Ardèche-Drôme-Isère-Puy-de-Dôme (LADIP) trial on atrial flutter, a multicentric prospective randomized study comparing amiodarone and radiofrequency ablation after the first episode of symptomatic atrial flutter. *Circulation* 2006;**114**:1676–1681.
 264. Satomi K, Chun KRJ, Tiltz R, Bansch D, Ernst S, Antz M, Schmidt B, Kuck K-H, Ouyang F. Catheter ablation of multiple unstable macroreentrant tachycardia within the right atrium free wall in patients without previous cardiac surgery. *Circ Arrhythm Electrophysiol* 2010;**3**:24–31.
 265. Jais P, Shah DC, Haissaguerre M, Hocini M, Peng JT, Takahashi A, Garrigue S, Le Metayer P, Clementy J. Mapping and ablation of left atrial flutters. *Circulation* 2000;**101**:2928–2934.
 266. Kall JG, Rubenstein DS, Kopp DE, Burke MC, Verdino RJ, Lin AC, Johnson CT, Cooke PA, Wang ZG, Fumo M, Wilber DJ. Atypical atrial flutter originating in the right atrial free wall. *Circulation* 2000;**101**:270–279.
 267. Nakagawa H, Shah N, Matsudaira K, Overholt E, Chandrasekaran K, Beckman KJ, Spector P, Calame JD, Rao A, Hasdemir C, Otomo K, Wang Z, Lazzara R, Jackman WM. Characterization of reentrant circuit in macroreentrant right atrial tachycardia after surgical repair of congenital heart disease: isolated channels between scars allow "focal" ablation. *Circulation* 2001;**103**:699–709.
 268. Ouyang F, Ernst S, Vogtmann T, Goya M, Volkmer M, Schaumann A, Bansch D, Antz M, Kuck K-H. Characterization of reentrant circuits in left atrial macroreentrant tachycardia: critical isthmus block can prevent atrial tachycardia recurrence. *Circulation* 2002;**105**:1934–1942.
 269. Tai C-T, Huang J-L, Lin Y-K, Hsieh M-H, Lee P-C, Ding Y-A, Chang M-S, Chen S-A. Noncontact three-dimensional mapping and ablation of upper loop reentry originating in the right atrium. *J Am Coll Cardiol* 2002;**40**:746–753.
 270. Blackshear JL, Stambler BS, Strauss WE, Roy D, Dias VC, Beach CL, Ebener MK. Control of heart rate during transition from intravenous to oral diltiazem in atrial fibrillation or flutter. *Am J Cardiol* 1996;**78**:1246–1250.
 271. Brodsky MA, Allen BJ, Grimes JA, Gold C. Enhanced atrioventricular conduction during atrial flutter after intravenous adenosine. *N Engl J Med* 1994;**330**:288–289.
 272. Strickberger SA, Man KC, Daoud EG, Goyal R, Brinkman K, Knight BP, Weiss R, Bahu M, Morady F. Adenosine-induced atrial arrhythmia: a prospective analysis. *Ann Intern Med* 1997;**127**:417–422.
 273. Crozier IG, Ikram H, Kenealy M, Levy L. Flecainide acetate for conversion of acute supraventricular tachycardia to sinus rhythm. *Am J Cardiol* 1987;**59**:607–609.
 274. Murdock CJ, Kyles AE, Yeung-Lai-Wah JA, Qi A, Vorderbrugge S, Kerr CR. Atrial flutter in patients treated for atrial fibrillation with propafenone. *Am J Cardiol* 1990;**66**:755–757.
 275. Bianconi L, Castro A, Dinelli M, Alboni P, Pappalardo A, Richiardi E, Santini M. Comparison of intravenously administered dofetilide versus amiodarone in the acute termination of atrial fibrillation and flutter. A multicentre, randomized, double-blind, placebo-controlled study. *Eur Heart J* 2000;**21**:1265–1273.

276. Kafkas NV, Patsilinos SP, Mertzanos GA, Papageorgiou KI, Chaveles JJ, Dagadaki OK, Kelesidis KM. Conversion efficacy of intravenous ibutilide compared with intravenous amiodarone in patients with recent-onset atrial fibrillation and atrial flutter. *Int J Cardiol* 2007;**118**:321–325.
277. Heisel A, Jung J, Stopp M, Schieffer H. Facilitating influence of procainamide on conversion of atrial flutter by rapid atrial pacing. *Eur Heart J* 1997;**18**:866–869.
278. Katritsis DG, Josephson ME. Anticoagulation for cardioversion of acute onset atrial fibrillation: time to revise guidelines? *JACC Clin Electrophysiol* 2016;**2**:495–497.
279. Schwartzman D, Callans DJ, Gottlieb CD, Dillon SM, Movsowitz C, Marchlinski FE. Conduction block in the inferior vena caval-tricuspid valve isthmus: association with outcome of radiofrequency ablation of type I atrial flutter. *J Am Coll Cardiol* 1996;**28**:1519–1531.
280. De Bortoli A, Shi LB, Ohm OJ, Hoff PI, Schuster P, Solheim E, Chen J. Incidence and clinical predictors of subsequent atrial fibrillation requiring additional ablation after cavotricuspid isthmus ablation for typical atrial flutter. *Scand Cardiovasc J* 2017;**51**:123–128.
281. Benditt DG, Williams JH, Jin J, Deering TF, Zucker R, Browne K, Chang-Sing P, Singh BN. Maintenance of sinus rhythm with oral d,l-Sotalol therapy in patients with symptomatic atrial fibrillation and/or atrial flutter. d,l-Sotalol Atrial Fibrillation/Flutter Study Group. *Am J Cardiol* 1999;**84**:270–277.
282. Grimm RA, Stewart WJ, Arheart KL, Thomas JD, Klein AL. Left atrial appendage “stunning” after electrical cardioversion of atrial flutter: an attenuated response compared with atrial fibrillation as the mechanism for lower susceptibility to thromboembolic events. *J Am Coll Cardiol* 1997;**29**:582–589.
283. Bochoeyer A, Yang Y, Cheng J, Lee RJ, Keung EC, Marrouche NF, Natale A, Scheinman MM. Surface electrocardiographic characteristics of right and left atrial flutter. *Circulation* 2003;**108**:60–66.
284. Cheng J, Cabeen WR Jr, Scheinman MM. Right atrial flutter due to lower loop reentry: mechanism and anatomic substrates. *Circulation* 1999;**99**:1700–1705.
285. Zhang S, Younis G, Hariharan R, Ho J, Yang Y, Ip J, Thakur RK, Seger J, Scheinman MM, Cheng J. Lower loop reentry as a mechanism of clockwise right atrial flutter. *Circulation* 2004;**109**:1630–1635.
286. Yang Y, Cheng J, Bochoeyer A, Hamdan MH, Kowal RC, Page R, Lee RJ, Steiner PR, Saxon LA, Lesh MD, Modin GV, Scheinman MM. Atypical right atrial flutter patterns. *Circulation* 2001;**103**:3092–3098.
287. Yang Y, Varma N, Badhwar N, Tanel RE, Sundara S, Lee RJ, Lee BK, Tseng ZH, Marcus GM, Kim AM, Olgin JE, Scheinman MM. Prospective observations in the clinical and electrophysiological characteristics of intra-isthmus reentry. *J Cardiovasc Electrophysiol* 2010;**21**:1099–1106.
288. Zrenner B, Dong JUN, Schreieck J, Ndrepepa G, Meisner H, Kaemmerer H, Schömig A, Hess J, Schmitt C. Delineation of intra-atrial reentrant tachycardia circuits after mustard operation for transposition of the great arteries using biatrial electroanatomic mapping and entrainment mapping. *J Cardiovasc Electrophysiol* 2003;**14**:1302–1310.
289. Ueda A, Suman-Horduna I, Mantziari L, Gujic M, Marchese P, Ho SY, Babu-Narayan SV, Ernst S. Contemporary outcomes of supraventricular tachycardia ablation in congenital heart disease: a single-center experience in 116 patients. *Circ Arrhythm Electrophysiol* 2013;**6**:606–613.
290. Akca F, Bauernfeind T, De Groot NMS, Shalghanov T, Schwagten B, Szili-Torok T. The presence of extensive atrial scars hinders the differential diagnosis of focal or macroreentrant atrial tachycardias in patients with complex congenital heart disease. *Europace* 2014;**16**:893–898.
291. Shah D, Jais P, Takahashi A, Hocini M, Peng JT, Clementy J, Haissaguerre M. Dual-loop intra-atrial reentry in humans. *Circulation* 2000;**101**:631–639.
292. Scaglione M, Caponi D, Ebrille E, Di Donna P, Di Clemente F, Battaglia A, Raimondo C, Appendino M, Gaita F. Very long-term results of electroanatomic-guided radiofrequency ablation of atrial arrhythmias in patients with surgically corrected atrial septal defect. *Europace* 2014;**16**:1800–1807.
293. Gucuk Ipek E, Marine JE, Habibi M, Chrispin J, Lima J, Rickard J, Spragg D, Zimmerman SL, Zipunnikov V, Berger R, Calkins H, Nazarian S. Association of left atrial function with incident typical atrial flutter after atrial fibrillation ablation. *Heart Rhythm* 2016;**13**:391–398.
294. Gerstenfeld EP, Callans DJ, Dixit S, Russo AM, Nayak H, Lin D, Pulliam W, Siddique S, Marchlinski FE. Mechanisms of organized left atrial tachycardias occurring after pulmonary vein isolation. *Circulation* 2004;**110**:1351–1357.
295. Wasmer K, Mönning G, Bittner A, Dechering D, Zellerhoff S, Milberg P, Köbe J, Eckardt L. Incidence, characteristics, and outcome of left atrial tachycardias after circumferential antral ablation of atrial fibrillation. *Heart Rhythm* 2012;**9**:1660–1666.
296. Satomi K, Bänsch D, Tilz R, Chun J, Ernst S, Antz M, Gretten H, Kuck K-H, Ouyang F. Left atrial and pulmonary vein macroreentrant tachycardia associated with double conduction gaps: a novel type of man-made tachycardia after circumferential pulmonary vein isolation. *Heart Rhythm* 2008;**5**:43–51.
297. Katritsis D, Wood MA, Shepard RK, Giazitzoglou E, Kourlaba G, Ellenbogen KA. Atrial arrhythmias following ostial or circumferential pulmonary vein ablation. *J Interv Card Electrophysiol* 2006;**16**:123–130.
298. Barbhaya CR, Baldinger SH, Kumar S, Chinitz JS, Enriquez AD, John R, Stevenson WG, Michaud GF. Downstream overdrive pacing and intracardiac concealed fusion to guide rapid identification of atrial tachycardia after atrial fibrillation ablation. *Europace* 2018;**20**:596–603.
299. Johner N, Shah DC, Jousset F, Dall'Aglio PB, Namdar M. Electrophysiological and anatomical correlates of sites with postpacing intervals shorter than tachycardia cycle length in atypical atrial flutter. *Circ Arrhythm Electrophysiol* 2019;**12**:e006955.
300. Yokokawa M, Latchamsetty R, Ghanbari H, Belardi D, Makkar A, Roberts B, Saint-Phard W, Sinno M, Carrigan T, Kennedy R, Suwanagool A, Good E, Crawford T, Jongnarangsin K, Pelosi F, Bogun F, Oral H, Morady F, Chugh A. Characteristics of atrial tachycardia due to small vs large reentrant circuits after ablation of persistent atrial fibrillation. *Heart Rhythm* 2013;**10**:469–476.
301. Chang S-L, Tsao H-M, Lin Y-J, Lo L-W, Hu Y-F, Tuan T-C, Tsai W-C, Chang C-J, Suenari K, Huang S-Y, Tai C-T, Li C-H, Chao T-F, Wu T-J, Chen S-A. Differentiating macroreentrant from focal atrial tachycardias occurred after circumferential pulmonary vein isolation. *J Cardiovasc Electrophysiol* 2011;**22**:748–755.
302. Gerstenfeld EP, Dixit S, Bala R, Callans DJ, Lin D, Sauer W, Garcia F, Cooper J, Russo AM, Marchlinski FE. Surface electrocardiogram characteristics of atrial tachycardias occurring after pulmonary vein isolation. *Heart Rhythm* 2007;**4**:1136–1143.
303. Markowitz SM, Brodman RF, Stein KM, Mittal S, Slotwiner DJ, Iwai S, Das MK, Lerman BB. Lesional tachycardias related to mitral valve surgery. *J Am Coll Cardiol* 2002;**39**:1973–1983.
304. Takahashi K, Miyauchi Y, Hayashi M, Iwasaki Y-k, Yodogawa K, Tsuboi I, Hayashi H, Oka E, Ito Hagiwara K, Fujimoto Y, Shimizu W. Mechanisms of postoperative atrial tachycardia following biatrial surgical ablation of atrial fibrillation in relation to the surgical lesion sets. *Heart Rhythm* 2016;**13**:1059–1065.
305. Zhang J, Tang C, Zhang Y, Han H, Li Z, Su X. Electroanatomic characterization and ablation outcome of nonlesion related left atrial macroreentrant tachycardia in patients without obvious structural heart disease. *J Cardiovasc Electrophysiol* 2013;**24**:53–59.
306. Fukamizu S, Sakurada H, Hayashi T, Hojo R, Komiyama K, Tanabe Y, Tejima T, Nishizaki M, Kobayashi Y, Hiraoka M. Macroreentrant atrial tachycardia in patients without previous atrial surgery or catheter ablation: clinical and electrophysiological characteristics of scar-related left atrial anterior wall reentry. *J Cardiovasc Electrophysiol* 2013;**24**:404–412.
307. Marrouche NF, Natale A, Wazni OM, Cheng J, Yang Y, Pollack H, Verma A, Ursell P, Scheinman MM. Left septal atrial flutter: electrophysiology, anatomy, and results of ablation. *Circulation* 2004;**109**:2440–2447.
308. Sawhney N, Anand K, Robertson CE, Wurdeman T, Anousheh R, Feld GK. Recovery of mitral isthmus conduction leads to the development of macroreentrant tachycardia after left atrial linear ablation for atrial fibrillation. *Circ Arrhythm Electrophysiol* 2011;**4**:832–837.
309. Miyazaki S, Shah AJ, Hocini M, Haïssaguerre M, Jais P. Recurrent spontaneous clinical perimitral atrial tachycardia in the context of atrial fibrillation ablation. *Heart Rhythm* 2015;**12**:104–110.
310. Ammar S, Luik A, Hessling G, Bruhm A, Reents T, Semmler V, Buiatti A, Kathan S, Hofmann M, Kolb C, Schmitt C, Deisenhofer I. Ablation of perimitral flutter: acute and long-term success of the modified anterior line. *Europace* 2015;**17**:447–452.
311. Chugh A, Oral H, Lemola K, Hall B, Cheung P, Good E, Tamirisa K, Han J, Bogun F, Pelosi F, Morady F. Prevalence, mechanisms, and clinical significance of macroreentrant atrial tachycardia during and following left atrial ablation for atrial fibrillation. *Heart Rhythm* 2005;**2**:464–471.
312. Nikolaidou T, Aslanidi OV, Zhang H, Efimov IR. Structure–function relationship in the sinus and atrioventricular nodes. *Pediatr Cardiol* 2012;**33**:890–899.
313. Hucker WJ, McCain ML, Laughner JL, Iazzo PA, Efimov IR. Connexin 43 expression delineates two discrete pathways in the human atrioventricular junction. *Anat Rec (Hoboken)* 2008;**291**:204–215.
314. Katritsis DG, Efimov IR. Cardiac connexin genotyping for identification of the circuit of atrioventricular nodal re-entrant tachycardia. *Europace* 2018;**21**:190–191.
315. Katritsis DG, Becker AE, Ellenbogen KA, Giazitzoglou E, Korovesis S, Camm AJ. Effect of slow pathway ablation in atrioventricular nodal reentrant tachycardia on the electrophysiologic characteristics of the inferior atrial inputs to the human atrioventricular node. *Am J Cardiol* 2006;**97**:860–865.
316. Katritsis DG, Ellenbogen KA, Becker AE, Camm AJ. Retrograde slow pathway conduction in patients with atrioventricular nodal re-entrant tachycardia. *Europace* 2007;**9**:458–465.
317. Katritsis DG, Sepahpour A, Marine JE, Katritsis GD, Tanawuttiwat T, Calkins H, Rowland E, Josephson ME. Atypical atrioventricular nodal reentrant tachycardia: prevalence, electrophysiologic characteristics, and tachycardia circuit. *Europace* 2015;**17**:1099–1106.
318. Pentinga ML, Meeder JG, Crijns HJGM, de Munck ED, Wiesfeld ACP, Lie KI. Late onset atrioventricular nodal tachycardia. *Int J Cardiol* 1993;**38**:293–298.

319. D'Este D, Zoppo F, Bertaglia E, Zerbo F, Picciolo A, Scarabeo V, Pascotto A, Pascotto P. Long-term outcome of patients with atrioventricular node reentrant tachycardia. *Int J Cardiol* 2007;**115**:350–353.
320. Sauer WH, Alonso C, Zado E, Cooper JM, Lin D, Dixit S, Russo A, Verdino R, Ji S, Gerstenfeld EP, Callans DJ, Marchlinski FE. Atrioventricular nodal reentrant tachycardia in patients referred for atrial fibrillation ablation: response to ablation that incorporates slow-pathway modification. *Circulation* 2006;**114**:191–195.
321. Michowitz Y, Anis-Heusler A, Reinstein E, Tovia-Brodie O, Glick A, Belhassen B. Familial occurrence of atrioventricular nodal reentrant tachycardia. *Circ Arrhythm Electrophysiol* 2017;**10**:e004680.
322. Katritsis DG, Josephson ME. Classification, electrophysiological features and therapy of atrioventricular nodal reentrant tachycardia. *Arrhythm Electrophysiol Rev* 2016;**5**:130–135.
323. Katritsis DG, Camm AJ. Atrioventricular nodal reentrant tachycardia. *Circulation* 2010;**122**:831–840.
324. Katritsis DG, Josephson ME. Classification of electrophysiological types of atrioventricular nodal re-entrant tachycardia: a reappraisal. *Europace* 2013;**15**:1231–1240.
325. Yamabe H, Tanaka Y, Morihisa K, Uemura T, Enomoto K, Kawano H, Ogawa H. Analysis of the anatomical tachycardia circuit in verapamil-sensitive atrial tachycardia originating from the vicinity of the atrioventricular node. *Circ Arrhythm Electrophysiol* 2010;**3**:54–62.
326. Engelstein ED, Stein KM, Markowitz SM, Lerman BB. Posterior fast atrioventricular node pathways: Implications for radiofrequency catheter ablation of atrioventricular node reentrant tachycardia. *J Am Coll Cardiol* 1996;**27**:1098–1105.
327. Katritsis DG, Ellenbogen KA, Becker AE. Atrial activation during atrioventricular nodal reentrant tachycardia: studies on retrograde fast pathway conduction. *Heart Rhythm* 2006;**3**:993–1000.
328. Nam G-B, Rhee K-S, Kim JUN, Choi K-J, Kim Y-H. Left atrionodal connections in typical and atypical atrioventricular nodal reentrant tachycardias: activation sequence in the coronary sinus and results of radiofrequency catheter ablation. *J Cardiovasc Electrophysiol* 2006;**17**:171–177.
329. Katritsis DG, Marine JE, Latchamsetty R, Zografos T, Tanawuttawat T, Sheldon SH, Buxton AE, Calkins H, Morady F, Josephson ME. Coexistent types of atrioventricular nodal re-entrant tachycardia. Implications for the tachycardia circuit. *Circ Arrhythm Electrophysiol* 2015;**8**:1189–1193.
330. Miljoen H, Ector J, Garweg C, Saenen J, Huybrechts W, Sarkozy A, Willems R, Heidbuchel H. Differential presentation of atrioventricular nodal re-entrant tachycardia in athletes and non-athletes. *Europace* 2019;**21**:944–949.
331. Nawata H, Yamamoto N, Hirao K, Miyasaka N, Kawara T, Hiejima K, Harada T, Suzuki F. Heterogeneity of anterograde fast-pathway and retrograde slow-pathway conduction patterns in patients with the fast–slow form of atrioventricular nodal reentrant tachycardia: electrophysiologic and electrocardiographic considerations. *J Am Coll Cardiol* 1998;**32**:1731–1740.
332. Hwang C, Martin DJ, Goodman JS, Gang HS, Mandel WJ, Swerdlow CD, Peter CT, Chen P-S. Atypical atrioventricular node reciprocating tachycardia masquerading as tachycardia using a left-sided accessory pathway. *J Am Coll Cardiol* 1997;**30**:218–225.
333. Sakabe K, Wakatsuki T, Fujinaga H, Oishi Y, Ikata J, Toyoshima T, Hiura N, Nishikado A, Oki T, Ito S. Patient with atrioventricular node reentrant tachycardia with eccentric retrograde left-sided activation: treatment with radiofrequency catheter ablation. *Jpn Heart J* 2000;**41**:227–234.
334. Vijayarajan P, Kok LC, Rhee B, Ellenbogen KA. Unusual variant of atrioventricular nodal reentrant tachycardia. *Heart Rhythm* 2005;**2**:100–102.
335. Heidbuchel H, Jackman WM. Characterization of subforms of AV nodal reentrant tachycardia. *Europace* 2004;**6**:316–329.
336. Katritsis DG, Zografos T, Katritsis GD, Giatzizoglou E, Vachliotis V, Paxinos G, Camm AJ, Josephson ME. Catheter ablation vs. antiarrhythmic drug therapy in patients with symptomatic atrioventricular nodal re-entrant tachycardia: a randomized, controlled trial. *Europace* 2017;**19**:602–606.
337. Katritsis DG, John RM, Latchamsetty R, Muthalaly RG, Zografos T, Katritsis GD, Stevenson WG, Efimov IR, Morady F. Left septal slow pathway ablation for atrioventricular nodal reentrant tachycardia. *Circ Arrhythm Electrophysiol* 2018;**11**:e005907.
338. Katritsis DG, Marine JE, Contreras FM, Fujii A, Latchamsetty R, Siontis KC, Katritsis GD, Zografos T, John RM, Epstein LM, Michaud GF, Anter E, Sepahpour A, Rowland E, Buxton AE, Calkins H, Morady F, Stevenson WG, Josephson ME. Catheter ablation of atypical atrioventricular nodal reentrant tachycardia. *Circulation* 2016;**134**:1655–1663.
339. Stavrakis S, Jackman WM, Lockwood D, Nakagawa H, Beckman K, Elkholey K, Wang Z, Po SS. Slow/fast atrioventricular nodal reentrant tachycardia using the inferolateral left atrial slow pathway. *Circ Arrhythm Electrophysiol* 2018;**11**:e006631.
340. Rinkenberger RL, Prystowsky EN, Heger JJ, Troup PJ, Jackman WM, Zipes DP. Effects of intravenous and chronic oral verapamil administration in patients with supraventricular tachyarrhythmias. *Circulation* 1980;**62**:996–1010.
341. Winniford MD, Fulton KL, Hills LD. Long-term therapy of paroxysmal supraventricular tachycardia: a randomized, double-blind comparison of digoxin, propranolol and verapamil. *Am J Cardiol* 1984;**54**:1138–1139.
342. Alboni P, Tomasi C, Menozzi C, Bottoni N, Paparella N, Fucà G, Brignole M, Cappato R. Efficacy and safety of out-of-hospital self-administered single-dose oral drug treatment in the management of infrequent, well-tolerated paroxysmal supraventricular tachycardia. *J Am Coll Cardiol* 2001;**37**:548–553.
343. Yeh SJ, Lin FC, Chou YY, Hung JS, Wu D. Termination of paroxysmal supraventricular tachycardia with a single oral dose of diltiazem and propranolol. *Circulation* 1985;**71**:104–109.
344. Musto B, Cavallaro C, Musto A, D'Onofrio A, Belli A, De Vincentis L. Flecainide single oral dose for management of paroxysmal supraventricular tachycardia in children and young adults. *Am Heart J* 1992;**124**:110–115.
345. Goldberg AS, Bathina MN, Mickelsen S, Nawman R, West G, Kusumoto FM. Long-term outcomes on quality-of-life and health care costs in patients with supraventricular tachycardia (radiofrequency catheter ablation versus medical therapy). *Am J Cardiol* 2002;**89**:1120–1123.
346. Larson MS, McDonald K, Young C, Sung R, Hlatky MA. Quality of life before and after radiofrequency catheter ablation in patients with drug refractory atrioventricular nodal reentrant tachycardia. *Am J Cardiol* 1999;**84**:471–473.
347. Bathina M, Mickelsen S, Brooks C, Jaramillo J, Hepton T, Kusumoto F. Radiofrequency catheter ablation versus medical therapy for initial treatment of supraventricular tachycardia and its impact on quality of life and healthcare costs. *Am J Cardiol* 1998;**82**:589–593.
348. Cheng CF, Sanders GD, Hlatky MA, Heidenreich P, McDonald KM, Lee BK, Larson MS, Owens DK. Cost-effectiveness of radiofrequency ablation for supraventricular tachycardia. *Ann Intern Med* 2000;**133**:864–876.
349. Kalbfleisch SJ, Calkins H, Langberg JJ, El-Atassi R, Leon A, Borganeli M, Morady F. Comparison of the cost of radiofrequency catheter modification of the atrioventricular node and medical therapy for drug-refractory atrioventricular node reentrant tachycardia. *J Am Coll Cardiol* 1992;**19**:1583–1587.
350. Kalbfleisch SJ, Strickberger SA, Williamson B, Vorperian VR, Man C, Hummel JD, Langberg JJ, Morady F. Randomized comparison of anatomic and electrogram mapping approaches to ablation of the slow pathway of atrioventricular node reentrant tachycardia. *J Am Coll Cardiol* 1994;**23**:716–723.
351. Katritsis DG, Giatzizoglou E, Zografos T, Ellenbogen KA, Camm AJ. An approach to left septal slow pathway ablation. *J Interv Card Electrophysiol* 2011;**30**:73–79.
352. Morady F. Catheter ablation of supraventricular arrhythmias: state of the art. *Heart Rhythm* 2004;**1**:C67–C84.
353. Van Hare GF, Javitz H, Carmelli D, Saul JP, Tanel RE, Fischbach PS, Kanter RJ, Schaffer M, Dunnigan A, Colan S, Serwer G; Pediatric Electrophysiology Society. Prospective assessment after pediatric cardiac ablation: demographics, medical profiles, and initial outcomes. *J Cardiovasc Electrophysiol* 2004;**15**:759–770.
354. Katritsis DG. Catheter ablation of atrioventricular nodal re-entrant tachycardia: facts and fiction. *Arrhythm Electrophysiol Rev* 2018;**7**:230–231.
355. Chen H, Shehata M, Ma W, Xu J, Cao J, Cingolani E, Swerdlow C, Chen M, Chugh SS, Wang X. Atrioventricular block during slow pathway ablation: entirely preventable? *Circ Arrhythm Electrophysiol* 2015;**8**:739–744.
356. Papagiannis J, Beissel DJ, Krause U, Cabrera M, Telishevska M, Seslar S, Johnsrude C, Anderson C, Tisma-Dupanovic S, Connelly D, Avramidis D, Carter C, Kornyei L, Law I, Von Bergen N, Janusek J, Silva J, Rosenthal E, Willcox M, Kubus P, Hessling G, Paul T; Paediatric and Congenital Electrophysiology Society. Atrioventricular nodal reentrant tachycardia in patients with congenital heart disease. Outcome after catheter ablation. *Circ Arrhythm Electrophysiol* 2017;**10**:e004869.
357. Backhoff D, Klehs S, Müller MJ, Schneider HE, Kriebel T, Paul T, Krause U. Long-term follow-up after catheter ablation of atrioventricular nodal reentrant tachycardia in children. *Circ Arrhythm Electrophysiol* 2016;**9**:e004264.
358. Skeberis V, Simonis F, Tsakonas K, Celiker Alp AY, Andries E, Brugada P. Inappropriate sinus tachycardia following radiofrequency ablation of AV nodal tachycardia: incidence and clinical significance. *Pacing Clin Electrophysiol* 1994;**17**:924–927.
359. Rostock T, Risius T, Ventura R, Klemm HU, Weiss C, Keitel A, Meinertz T, Willems S. Efficacy and safety of radiofrequency catheter ablation of atrioventricular nodal reentrant tachycardia in the elderly. *J Cardiovasc Electrophysiol* 2005;**16**:608–610.
360. Li YG, Gronefeld G, Bender B, Machura C, Hohnloser SH. Risk of development of delayed atrioventricular block after slow pathway modification in patients with atrioventricular nodal reentrant tachycardia and a pre-existing prolonged PR interval. *Eur Heart J* 2001;**22**:89–95.
361. Deisenhofer I, Zrenner B, Yin Y-h, Pitschner H-F, Kuniss M, Grossmann G, Stiller S, Luik A, Veltmann C, Frank J, Linner J, Estner HL, Pflaumer A, Wu J, von Bary C, Ucer E, Reents T, Tzeis S, Fichtner S, Kathan S, Karch MR, Jilek C, Ammar S, Kolb C, Liu Z-C, Haller B, Schmitt C, Hessling G. Cryoablation

- versus radiofrequency energy for the ablation of atrioventricular nodal reentrant tachycardia (the CYRANO Study): results from a large multicenter prospective randomized trial. *Circulation* 2010;**122**:2239–2245.
362. Hanninen M, Yeung-Lai-Wah N, Massel D, Gula LJ, Skanes AC, Yee R, Klein GJ, Manlucu J, Leong-Sit P. Cryoablation versus RF ablation for AVNRT: a meta-analysis and systematic review. *J Cardiovasc Electrophysiol* 2013;**24**:1354–1360.
 363. Matta M, Anselmino M, Scaglione M, Vitolo M, Ferraris F, Di Donna P, Caponi D, Castagno D, Gaita F. Cooling dynamics: a new predictor of long-term efficacy of atrioventricular nodal reentrant tachycardia cryoablation. *J Interv Card Electrophysiol* 2017;**48**:333–341.
 364. Pieragnoli P, Paoletti Perini A, Checchi L, Carrassa G, Giomi A, Carrai P, Michelucci A, Padeletti L, Ricciardi G. Cryoablation of typical AVNRT: younger age and administration of bonus ablation favor long-term success. *Heart Rhythm* 2015;**12**:2125–2131.
 365. Enriquez A, Ellenbogen KA, Boles U, Baranchuk A. Atrioventricular nodal reentrant tachycardia in implantable cardioverter defibrillators: diagnosis and troubleshooting. *J Cardiovasc Electrophysiol* 2015;**26**:1282–1288.
 366. Walsh EP, Saul JP, Sholler GF, Triedman JK, Jonas RA, Mayer JE, Wessel DL. Evaluation of a staged treatment protocol for rapid automatic junctional tachycardia after operation for congenital heart disease. *J Am Coll Cardiol* 1997;**29**:1046–1053.
 367. Cools E, Missant C. Junctional ectopic tachycardia after congenital heart surgery. *Acta Anaesthesiol Belg* 2014;**65**:1–8.
 368. Collins KK, Van Hare GF, Kertesz NJ, Law IH, Bar-Cohen Y, Dubin AM, Etheridge SP, Berul CI, Avari JN, Tuzcu V, Sreeram N, Schaffer MS, Fournier A, Sanatani S, Snyder CS, Smith RT Jr, Arabia L, Hamilton R, Chun T, Liberman L, Kakavand B, Paul T, Tanel RE. Pediatric nonpost-operative junctional ectopic tachycardia medical management and interventional therapies. *J Am Coll Cardiol* 2009;**53**:690–697.
 369. Hamdan M, Van Hare GF, Fisher W, Gonzalez R, Dorostkar P, Lee R, Lesh M, Saxon L, Kalman J, Scheinman M. Selective catheter ablation of the tachycardia focus in patients with nonreentrant junctional tachycardia. *Am J Cardiol* 1996;**78**:1292–1297.
 370. Ruder MA, Davis JC, Eldar M, Abbott JA, Griffin JC, Seger JJ, Scheinman MM. Clinical and electrophysiologic characterization of automatic junctional tachycardia in adults. *Circulation* 1986;**73**:930–937.
 371. Fishenfeld J, Desser KB, Benchimol A. Non-paroxysmal A-V junctional tachycardia associated with acute myocardial infarction. *Am Heart J* 1973;**86**:754–758.
 372. Kumagai K, Yamato H, Yamanouchi Y, Matsuo K, Tashiro N, Hiroki T, Arakawa K. Automatic junctional tachycardia in an adult. *Clinical Cardiology* 1990;**13**:813–816.
 373. Cook JR, Steinberg JS. An incessant form of junctional ectopic tachycardia in an adult responsive to a class 1C agent. *Am Heart J* 1991;**122**:1487–1489.
 374. Amrousy DE, Elshehaby W, Feky WE, Elshmaa NS. Safety and efficacy of prophylactic amiodarone in preventing early junctional ectopic tachycardia (JET) in children after cardiac surgery and determination of its risk factor. *Pediatr Cardiol* 2016;**37**:734–739.
 375. Entenmann A, Michel M, Herberg U, Haas N, Kumpf M, Gass M, Egender F, Gebauer R. Management of postoperative junctional ectopic tachycardia in pediatric patients: a survey of 30 centers in Germany, Austria, and Switzerland. *Eur J Pediatr* 2017;**176**:1217–1226.
 376. Raja P, Hawker RE, Chaikittipinyo A, Cooper SG, Lau KC, Nunn GR, Cartmill TB, Sholler GF. Amiodarone management of junctional ectopic tachycardia after cardiac surgery in children. *Br Heart J* 1994;**72**:261–265.
 377. Sarubbi B, Musto B, Ducceschi V, D'Onofrio A, Cavallaro C, Vecchione F, Musto C, Calabrò R. Congenital junctional ectopic tachycardia in children and adolescents: a 20 year experience based study. *Heart* 2002;**88**:188–190.
 378. Dieks J-K, Klehs S, Müller MJ, Paul T, Krause U. Adjunctive ivabradine in combination with amiodarone: A novel therapy for pediatric congenital junctional ectopic tachycardia. *Heart Rhythm* 2016;**13**:1297–1302.
 379. Al-Ghamdi S, Al-Fayyadh MI, Hamilton RM. Potential new indication for ivabradine: treatment of a patient with congenital junctional ectopic tachycardia. *J Cardiovasc Electrophysiol* 2013;**24**:822–824.
 380. Kuck K-H, Kunze K-P, Schlüter M, Duckeck W. Encainide versus flecainide for chronic atrial and junctional ectopic tachycardia. *Am J Cardiol* 1988;**62**:L37–L44.
 381. Paul T, Reimer A, Janousek J, Kalifelz H-C. Efficacy and safety of propafenone in congenital junctional ectopic tachycardia. *J Am Coll Cardiol* 1992;**20**:911–914.
 382. Hamdan MH, Badhwar N, Scheinman MM. Role of invasive electrophysiologic testing in the evaluation and management of adult patients with focal junctional tachycardia. *Card Electrophysiol Rev* 2002;**6**:431–435.
 383. Law IH, Von Bergen NH, Gingerich JC, Saarel EV, Fischbach PS, Dick M. Transcatheter cryothermal ablation of junctional ectopic tachycardia in the normal heart. *Heart Rhythm* 2006;**3**:903–907.
 384. Jackowska-Zduniak B, Forsy U. Mathematical model of the atrioventricular nodal double response tachycardia and double-fire pathology. *Math Biosci Eng* 2016;**13**:1143–1158.
 385. Peiker C, Pott C, Eckardt L, Kelm M, Shin DI, Willems S, Meyer C. Dual atrioventricular nodal non-re-entrant tachycardia. *Europace* 2016;**18**:332–339.
 386. Yokoshiki H, Sasaki K, Shimokawa J, Sakurai M, Tsutsui H. Nonreentrant atrioventricular nodal tachycardia due to triple nodal pathways manifested by radiofrequency ablation at coronary sinus ostium. *J Electrocardiol* 2006;**39**:395–399.
 387. Itagaki T, Ohnishi Y, Inoue T, Yokoyama M. Linking phenomenon in dual atrioventricular nodal pathways. *Jpn Circ J* 2001;**65**:937–940.
 388. Arena G, Bongiorni MG, Soldati E, Gherarducci G, Mariani M. Incessant non-reentrant atrioventricular nodal tachycardia due to multiple nodal pathways treated by radiofrequency ablation of the slow pathways. *J Cardiovasc Electrophysiol* 1999;**10**:1636–1642.
 389. Wang NC. Dual atrioventricular nodal nonreentrant tachycardia: a systematic review. *Pacing Clin Electrophysiol* 2011;**34**:1671–1681.
 390. Ho SY. Accessory atrioventricular pathways: getting to the origins. *Circulation* 2008;**117**:1502–1504.
 391. Jackman WM, Wang XZ, Friday KJ, Roman CA, Moulton KP, Beckman KJ, McClelland JH, Twidale N, Hazlett HA, Prior MI, Margolis PD, Calame JD, Overholt ED, Lazzara R. Catheter ablation of accessory atrioventricular pathways (Wolff-Parkinson-White syndrome) by radiofrequency current. *N Engl J Med* 1991;**324**:1605–1611.
 392. Katritsis D, Bashir Y, Heald S, Poloniecki J, Ward DE. Radiofrequency ablation of accessory pathways: implications of accumulated experience and time dedicated to procedures. *Eur Heart J* 1994;**15**:339–344.
 393. Schlüter M, Geiger M, Siebels J, Duckeck W, Kuck KH. Catheter ablation using radiofrequency current to cure symptomatic patients with tachyarrhythmias related to an accessory atrioventricular pathway. *Circulation* 1991;**84**:1644–1661.
 394. Liu Q, Shehata M, Lan DZ, Ehdia A, Cingolani E, Chugh SS, Fu G, Jiang C, Wang X. Accurate localization and catheter ablation of superoparaseptal accessory pathways. *Heart Rhythm* 2018;**15**:688–695.
 395. Kuck KH, Friday KJ, Kunze KP, Schlüter M, Lazzara R, Jackman WM. Sites of conduction block in accessory atrioventricular pathways. Basis for concealed accessory pathways. *Circulation* 1990;**82**:407–417.
 396. Cappato R, Schlüter M, Weiss C, Antz M, Koschky DH, Hofmann T, Kuck KH. Radiofrequency current catheter ablation of accessory atrioventricular pathways in Ebstein's anomaly. *Circulation* 1996;**94**:376–383.
 397. Bhatia A, Sra J, Akhtar M. Preexcitation syndromes. *Curr Probl Cardiol* 2016;**41**:99–137.
 398. Koneru JN, Wood MA, Ellenbogen KA. Rare forms of preexcitation: a case study and brief overview of familial forms of preexcitation. *Circ Arrhythm Electrophysiol* 2012;**5**:e82–e87.
 399. Xie B, Heald SC, Bashir Y, Katritsis D, Murgatroyd FD, Camm AJ, Rowland E, Ward DE. Localization of accessory pathways from the 12-lead electrocardiogram using a new algorithm. *Am J Cardiol* 1994;**74**:161–165.
 400. Pambrun T, El Bouazzaoui R, Combes N, Combes S, Sousa P, Le Bloa M, Massoullie G, Cheniti G, Martin R, Pillois X, Duchateau J, Sacher F, Hocini M, Jais P, Derval N, Bortone A, Boveda S, Denis A, Haissaguerre M, Albenque JP. Maximal pre-excitation based algorithm for localization of manifest accessory pathways in adults. *JACC Clin Electrophysiol* 2018;**4**:1052–1061.
 401. Basiouny T, de Chillou C, Fareh S, Kirkorian G, Messier M, Sadou N, Chevalier P, Magnin-Poull I, Blankoff I, Chen J, Touboul P, Aliot E. Accuracy and limitations of published algorithms using the twelve-lead electrocardiogram to localize overt atrioventricular accessory pathways. *J Cardiovasc Electrophysiol* 1999;**10**:1340–1349.
 402. Packer DL, Gallagher JJ, Prystowsky EN. Physiological substrate for antidromic reciprocating tachycardia. Prerequisite characteristics of the accessory pathway and atrioventricular conduction system. *Circulation* 1992;**85**:574–588.
 403. Brembilla-Perrot B, Pauriah M, Sellal JM, Zinzius PY, Schwartz J, de Chillou C, Cismaru G, Beurrier D, Voilliot D, Selton O, Louis P, Andronache M, Nosu R, de la Chaise AT. Incidence and prognostic significance of spontaneous and inducible antidromic tachycardia. *Europace* 2013;**15**:871–876.
 404. Ceresnak SR, Tanel RE, Pass RH, Liberman L, Collins KK, Van Hare GF, Gates GJ, Dubin AM. Clinical and electrophysiologic characteristics of antidromic tachycardia in children with Wolff-Parkinson-White syndrome. *Pacing Clin Electrophysiol* 2012;**35**:480–488.
 405. Etheridge SP, Escudero CA, Blaufox AD, Law IH, Dechert-Crooks BE, Stephenson EA, Dubin AM, Ceresnak SR, Motonaga KS, Skinner JR, Marcondes LD, Perry JC, Collins KK, Sessler SP, Cabrera M, Uzun O, Cannon BC, Aziz PF, Kubus P, Tanel RE, Valdes SO, Sami S, Kertesz NJ, Maldonado J, Erickson C, Moore JP, Asakai H, Mill L, Abcede M, Spector ZZ, Menon S, Shwayder M, Bradley DJ, Cohen MI, Sanatani S. Life-threatening event risk in children with Wolff-Parkinson-White syndrome: a multicenter international study. *JACC Clin Electrophysiol* 2018;**4**:433–444.
 406. Gemma LW, Steinberg LA, Prystowsky EN, Padanilam BJ. Development of rapid preexcited ventricular response to atrial fibrillation in a patient with intermittent preexcitation. *J Cardiovasc Electrophysiol* 2013;**24**:347–350.
 407. Kang KT, Potts JE, Radbill AE, La Page MJ, Papagiannis J, Garreiter JM, Kubus P, Kantoch MJ, Von Bergen NH, Fournier A, Côté J-M, Paul T, Anderson CC,

- Cannon BC, Miyake CY, Blaufox AD, Etheridge SP, Sanatani S. Permanent junctional reciprocating tachycardia in children: a multicenter experience. *Heart Rhythm* 2014;**11**:1426–1432.
408. Moore JP, Patel PA, Shannon KM, Albers EL, Salerno JC, Stein MA, Stephenson EA, Mohan S, Shah MJ, Asakai H, Pflaumer A, Czosek RJ, Everitt MD, Garnreiter JM, McCanta AC, Papez AL, Escudero C, Sanatani S, Cain NB, Kannankeril PJ, Bratincsak A, Mandapati R, Silva JNA, Knecht KR, Balaji S. Predictors of myocardial recovery in pediatric tachycardia-induced cardiomyopathy. *Heart Rhythm* 2014;**11**:1163–1169.
409. Kottkamp H, Hindricks G, Shenasa H, Chen X, Wichter T, Borggrefe M, Breithardt G. Variants of preexcitation–specialized atriofascicular pathways, nodofascicular pathways, and fasciculoventricular pathways: electrophysiologic findings and target sites for radiofrequency catheter ablation. *J Cardiovasc Electrophysiol* 1996;**7**:916–930.
410. Gandhavadi M, Sternick EB, Jackman WM, Wellens HJJ, Josephson ME. Characterization of the distal insertion of atriofascicular accessory pathways and mechanisms of QRS patterns in atriofascicular antidromic tachycardia. *Heart Rhythm* 2013;**10**:1385–1392.
411. Haissaguerre M, Cauchemez B, Marcus F, Le Metayer P, Lauribe P, Poquet F, Gencel L, Clementy J. Characteristics of the ventricular insertion sites of accessory pathways with anterograde decremental conduction properties. *Circulation* 1995;**91**:1077–1085.
412. Hluchy JAN, Schlegelmilch P, Schickel S, Jörgler URS, Jurkovicova O, Sabin GV. Radiofrequency ablation of a concealed nodoventricular Mahaim fiber guided by a discrete potential. *J Cardiovasc Electrophysiol* 1999;**10**:603–610.
413. Katritsis DG, Wellens HJ, Josephson ME. Mahaim accessory pathways. *Arrhythm Electrophysiol Rev* 2017;**6**:29–32.
414. de Alencar Neto JN, Ramalho de Moraes SR, Back Sternick E, Wellens HJJ. Atypical bypass tracts: can they be recognized during sinus rhythm? *Europace* 2019;**21**:208–218.
415. Francia P, Pittalis MC, Ali H, Cappato R. Electrophysiological study and catheter ablation of a Mahaim fibre located at the mitral annulus-aorta junction. *J Interv Card Electrophysiol* 2008;**23**:153–157.
416. Johnson CT, Brooks C, Jaramillo J, Mickelsen S, Kusumoto FM. A left free-wall, decrementally conducting, atrioventricular (Mahaim) fiber: diagnosis at electrophysiological study and radiofrequency catheter ablation guided by direct recording of a Mahaim potential. *Pacing Clin Electrophysiol* 1997;**20**:2486–2488.
417. Yamabe H, Okumura K, Minoda K, Yasue H. Nodoventricular Mahaim fiber connecting to the left ventricle. *Am Heart J* 1991;**122**:232–234.
418. Han FT, Riles EM, Badhwar N, Scheinman MM. Clinical features and sites of ablation for patients with incessant supraventricular tachycardia from concealed nodofascicular and nodoventricular tachycardias. *JACC Clin Electrophysiol* 2017;**3**:1547–1556.
419. Hamer A, Peter T, Platt M, Mandel WJ. Effects of verapamil on supraventricular tachycardia in patients with overt and concealed Wolff-Parkinson-White syndrome. *Am Heart J* 1981;**101**:600–612.
420. Huycke EC, Sung RJ, Dias VC, Reilstein S, Hariman RJ, Platia EV. Intravenous diltiazem for termination of reentrant supraventricular tachycardia: a placebo-controlled, randomized, double-blind, multicenter study. *J Am Coll Cardiol* 1989;**13**:538–544.
421. Glatzer KA, Dorostkar PC, Yang Y, Lee RJ, Van Hare GF, Keung E, Modin G, Scheinman MM. Electrophysiological effects of ibutilide in patients with accessory pathways. *Circulation* 2001;**104**:1933–1939.
422. Sellers TD Jr, Campbell RV, Bashore TM, Gallagher JJ. Effects of procainamide and quinidine sulfate in the Wolff-Parkinson-White syndrome. *Circulation* 1977;**55**:15–22.
423. Wellens HJJ, Brugada P, Abdollah H. Effect of amiodarone in paroxysmal supraventricular tachycardia with or without Wolff-Parkinson-White syndrome. *Am Heart J* 1983;**106**:876–880.
424. Holt P, Crick JCP, Davies DW, Curry P. Intravenous amiodarone in the acute termination of supraventricular arrhythmias. *Int J Cardiol* 1985;**8**:67–76.
425. Levy S, Ricard P. Using the right drug: a treatment algorithm for regular supraventricular tachycardias. *Eur Heart J* 1997;**18**:27–32.
426. Fujimura O, Kuo C-S, Smith BA. Pre-excited RR intervals during atrial fibrillation in the Wolff-Parkinson-White syndrome: influence of the atrioventricular node refractory period. *J Am Coll Cardiol* 1991;**18**:1722–1726.
427. Morady F, DiCarlo LA Jr, Baerman JM, De Buitler M. Effect of propranolol on ventricular rate during atrial fibrillation in the Wolff-Parkinson-White syndrome. *Pacing Clin Electrophysiol* 1987;**10**:492–496.
428. Sellers TD Jr, Bashore TM, Gallagher JJ. Digitalis in the pre-excitation syndrome. Analysis during atrial fibrillation. *Circulation* 1977;**56**:260–267.
429. Ludmer PL, McGowan NE, Antman EM, Friedman PL. Efficacy of propafenone in Wolff-Parkinson-White syndrome: electrophysiologic findings and long-term follow-up. *J Am Coll Cardiol* 1987;**9**:1357–1363.
430. Boahene KA, Klein GJ, Yee R, Sharma AD, Fujimura O. Termination of acute atrial fibrillation in the Wolff-Parkinson-White syndrome by procainamide and propafenone: importance of atrial fibrillatory cycle length. *J Am Coll Cardiol* 1990;**16**:1408–1414.
431. Crijns HJGM, den Heijer P, van Wijk LM, Lie KI. Successful use of flecainide in atrial fibrillation with rapid ventricular rate in the Wolff-Parkinson-White syndrome. *Am Heart J* 1988;**115**:1317–1321.
432. Boriani G, Biffi M, Frabetti L, Azzolini U, Sabbatani P, Bronzetti G, Capucci A, Magnani B. Ventricular fibrillation after intravenous amiodarone in Wolff-Parkinson-White syndrome with atrial fibrillation. *Am Heart J* 1996;**131**:1214–1216.
433. Schützenberger W, Leisch F, Gmeiner R. Enhanced accessory pathway conduction following intravenous amiodarone in atrial fibrillation. A case report. *Int J Cardiol* 1987;**16**:93–95.
434. Tijnelis MA, Herbert ME. Myth: intravenous amiodarone is safe in patients with atrial fibrillation and Wolff-Parkinson-White syndrome in the emergency department. *CJEM* 2005;**7**:262–265.
435. Kappenberger LJ, Fromer MA, Steinbrunn W, Shenasa M. Efficacy of amiodarone in the Wolff-Parkinson-White syndrome with rapid ventricular response via accessory pathway during atrial fibrillation. *Am J Cardiol* 1984;**54**:330–335.
436. Simonian SM, Lotfipour S, Wall C, Langdorf MI. Challenging the superiority of amiodarone for rate control in Wolff-Parkinson-White and atrial fibrillation. *Intern Emerg Med* 2010;**5**:421–426.
437. Kim SS, Lal R, Ruffy R. Treatment of paroxysmal reentrant supraventricular tachycardia with flecainide acetate. *Am J Cardiol* 1986;**58**:80–85.
438. Bravo L, Atienza F, Eidelman G, Ávila P, Pelliza M, Castellanos E, Loughlin G, Datino T, Torrecilla EG, Almendral J, Sánchez PL, Arenal Á, Martínez-Alzamora N, Fernández-Avilés F. Safety and efficacy of cryoablation vs. radiofrequency ablation of septal accessory pathways: systematic review of the literature and meta-analyses. *Europace* 2017;**20**:1334–1342.
439. Pappone C, Vicedomini G, Manguso F, Saviano M, Baldi M, Pappone A, Ciaccio C, Giannelli L, Ionescu B, Petretta A, Vitale R, Cuko A, Calovic Z, Fundaliotis A, Moscattello M, Tavazzi L, Santinelli V. Wolff-Parkinson-White syndrome in the era of catheter ablation: insights from a registry study of 2169 patients. *Circulation* 2014;**130**:811–819.
440. Xue Y, Zhan X, Wu S, Wang H, Liu Y, Liao Z, Deng H, Duan X, Zeng S, Liang D, Elvan A, Fang X, Liao H, Ramdat Misier AR, Smit JJJ, Metzner A, Heeger C-H, Liu F, Wang F, Zhang Z, Kuck K-H, Yen Ho S, Ouyang F. Experimental, pathologic, and clinical findings of radiofrequency catheter ablation of para-Hisian region from the right ventricle in dogs and humans. *Circ Arrhythm Electrophysiol* 2017;**10**:e005207.
441. Katritsis D, Giazitzoglou E, Korovesis S, Zambartas C. Comparison of the transseptal approach to the transaortic approach for ablation of left-sided accessory pathways in patients with Wolff-Parkinson-White syndrome. *Am J Cardiol* 2003;**91**:610–613.
442. Mauritsen DR, Winniford MD, Walker W, Rude RE, Cary JR, Hillis L. Oral verapamil for paroxysmal supraventricular tachycardia: a long-term, double-blind randomized trial. *Ann Intern Med* 1982;**96**:409–412.
443. Sakurai M, Yasuda H, Kato N, Nomura A, Fujita M, Nishino T, Fujita K, Koike Y, Saito H. Acute and chronic effects of verapamil in patients with paroxysmal supraventricular tachycardia. *Am Heart J* 1983;**105**:619–628.
444. Vassiliadis I, Papoutsakis P, Kallikazaros I, Stefanadis C. Propafenone in the prevention of non-ventricular arrhythmias associated with the Wolff-Parkinson-White syndrome. *Int J Cardiol* 1990;**27**:63–70.
445. Cockrell JL, Scheinman MM, Titus C, Helmy I, Langberg JJ, Lee MA, Griffin JC. Safety and efficacy of oral flecainide therapy in patients with atrioventricular reentrant tachycardia. *Ann Intern Med* 1991;**114**:189–194.
446. Schützenberger W, Leisch F, Gmeiner R. Enhanced accessory pathway conduction following intravenous amiodarone in atrial fibrillation. A case report. *Int J Cardiol* 1987;**16**:93–95.
447. Marazzato J, Fonte G, Marazzi R, Doni LA, Mitacchione G, Vilotta M, De Ponti R. Efficacy and safety of cryoablation of para-Hisian and mid-septal accessory pathways using a specific protocol: single-center experience in consecutive patients. *J Interv Card Electrophysiol* 2019;**55**:47–54.
448. Manolis AS, Wang PJ, Estes NA III. Radiofrequency ablation of left-sided accessory pathways: transaortic versus transseptal approach. *Am Heart J* 1994;**128**:896–902.
449. Obeyesekere MN, Leong-Sit P, Massel D, Manlucu J, Modi S, Krahn AD, Skanes AC, Yee R, Gula LJ, Klein GJ. Risk of arrhythmia and sudden death in patients with asymptomatic preexcitation. A meta-analysis. *Circulation* 2012;**125**:2308–2315.
450. Santinelli V, Radinovic A, Manguso F, Vicedomini G, Gulletta S, Paglino G, Mazonne P, Ciccone G, Sacchi S, Sala S, Pappone C. The natural history of asymptomatic ventricular pre-excitation: a long-term prospective follow-up study of 184 asymptomatic children. *J Am Coll Cardiol* 2009;**53**:275–280.
451. Klein GJ, Bashore TM, Sellers TD, Pritchett ELC, Smith WM, Gallagher JJ. Ventricular fibrillation in the Wolff-Parkinson-White syndrome. *N Engl J Med* 1979;**301**:1080–1085.
452. Kubuš P, Vít P, Gebauer RA, Materna O, Janoušek J. Electrophysiologic profile and results of invasive risk stratification in asymptomatic children and

- adolescents with the Wolff–Parkinson–White electrocardiographic pattern. *Circ Arrhythm Electrophysiol* 2014;**7**:218–223.
453. Pappone C, Santinelli V, Manguso F, Augello G, Santinelli O, Vicedomini G, Gulletta S, Mazzone P, Tortoriello V, Pappone A, Dicandia C, Rosanio S. A randomized study of prophylactic catheter ablation in asymptomatic patients with the Wolff-Parkinson-White Syndrome. *N Engl J Med* 2003;**349**:1803–1811.
 454. Santinelli V, Radinovic A, Manguso F, Vicedomini G, Ciconte G, Gulletta S, Paglino G, Sacchi S, Sala S, Ciaccio C, Pappone C. Asymptomatic ventricular preexcitation: a long-term prospective follow-up study of 293 adult patients. *Circ Arrhythm Electrophysiol* 2009;**2**:102–107.
 455. Montoya PT, Brugada P, Smeets J, Talajic M, Della Bella P, Lezaun R, Dool AVD, Wellens HJJ, De Luna AB, Oter R, Breithardt G, Borggrefe M, Klein H, Kuck KH, Kunze K, Coumel P, Leclercq JF, Chouty F, Frank R, Fontanine G. Ventricular fibrillation in the Wolff-Parkinson-White syndrome. *Eur Heart J* 1991;**12**:144–150.
 456. Pappone C, Vicedomini G, Manguso F, Baldi M, Pappone A, Petretta A, Vitale R, Saviano M, Ciaccio C, Giannelli L, Calovic Z, Tavazzi L, Santinelli V. Risk of malignant arrhythmias in initially symptomatic patients with Wolff-Parkinson-White syndrome: results of a prospective long-term electrophysiological follow-up study. *Circulation* 2012;**125**:661–668.
 457. Leitch JW, Klein GJ, Yee R, Murdock C. Prognostic value of electrophysiology testing in asymptomatic patients with Wolff-Parkinson-White pattern. *Circulation* 1990;**82**:1718–1723.
 458. Rinne C, Klein GJ, Sharma AD, Yee R, Milstein S, Rattes MF. Relation between clinical presentation and induced arrhythmias in the Wolff-Parkinson-White syndrome. *Am J Cardiol* 1987;**60**:576–579.
 459. Sharma AD, Yee R, Guiraudon G, Klein GJ. Sensitivity and specificity of invasive and noninvasive testing for risk of sudden death in Wolff-Parkinson-White syndrome. *J Am Coll Cardiol* 1987;**10**:373–381.
 460. Moore JP, Kannankeril PJ, Fish FA. Isoproterenol administration during general anesthesia for the evaluation of children with ventricular preexcitation. *Circ Arrhythm Electrophysiol* 2011;**4**:73–78.
 461. Daubert C, Ollitrault J, Descaves C, Mabo P, Ritter P, Gouffault J. Failure of the exercise test to predict the anterograde refractory period of the accessory pathway in Wolff Parkinson White syndrome. *Pacing Clin Electrophysiol* 1988;**11**:1130–1138.
 462. Wackel P, Irving C, Webber S, Beerman L, Arora G. Risk stratification in Wolff-Parkinson-White syndrome: the correlation between noninvasive and invasive testing in pediatric patients. *Pacing Clin Electrophysiol* 2012;**35**:1451–1457.
 463. Gaita F, Giustetto C, Riccardi R, Mangiardi L, Brusca A. Stress and pharmacologic tests as methods to identify patients with Wolff-Parkinson-White syndrome at risk of sudden death. *Am J Cardiol* 1989;**64**:487–490.
 464. Pediatric Congenital Electrophysiology S, Heart Rhythm S, American College of Cardiology F, American Heart A, American Academy of P, Canadian Heart Rhythm S, Cohen M, Triedman JK, Cannon BC, Davis AM, Drago F, Janousek J, Klein GJ, Law IH, Morady FJ, Paul T, Perry JC, Sanatani S, Tanel RE. PACES/HRS expert consensus statement on the management of the asymptomatic young patient with a Wolff-Parkinson-White (WPW, ventricular preexcitation) electrocardiographic pattern: developed in partnership between the Pediatric and Congenital Electrophysiology Society (PACES) and the Heart Rhythm Society (HRS). Endorsed by the governing bodies of PACES, HRS, the American College of Cardiology Foundation (ACCF), the American Heart Association (AHA), the American Academy of Pediatrics (AAP), and the Canadian Heart Rhythm Society (CHRS). *Heart Rhythm* 2012;**9**:1006–1024.
 465. Jastrzebski M, Kukla P, Pitak M, Rudzinski A, Baranchuk A, Czarnecka D. Intermittent preexcitation indicates "a low-risk" accessory pathway: time for a paradigm shift? *Ann Noninvasive Electrocardiol* 2017;**22**:e12464.
 466. Kiger ME, McCanta AC, Tong S, Schaffer M, Runciman M, Collins KK. Intermittent versus persistent Wolff-Parkinson-White syndrome in children: electrophysiologic properties and clinical outcomes. *Pacing Clin Electrophysiol* 2016;**39**:14–20.
 467. Cohen M. Intermittent preexcitation: should we rethink the current guidelines? *Pacing Clin Electrophysiol* 2016;**39**:9–11.
 468. Mah DY, Sherwin ED, Alexander ME, Cecchin F, Abrams DJ, Walsh EP, Triedman JK. The electrophysiological characteristics of accessory pathways in pediatric patients with intermittent preexcitation. *Pacing Clin Electrophysiol* 2013;**36**:1117–1122.
 469. Spar DS, Silver ES, Hordof AJ, Liberman L. Relation of the utility of exercise testing for risk assessment in pediatric patients with ventricular preexcitation to pathway location. *Am J Cardiol* 2012;**109**:1011–1014.
 470. Beckman KJ, Gallastegui JL, Bauman JL, Hariman RJ. The predictive value of electrophysiologic studies in untreated patients with Wolff-Parkinson-White syndrome. *J Am Coll Cardiol* 1990;**15**:640–647.
 471. Bunch TJ, May HT, Bair TL, Anderson JL, Crandall BG, Cutler MJ, Jacobs V, Mallender C, Muhlestein JB, Osborn JS, Weiss JP, Day JD. Long-term natural history of adult Wolff–Parkinson–White syndrome patients treated with and without catheter ablation. *Circ Arrhythm Electrophysiol* 2015;**8**:1465–1471.
 472. Cain N, Irving C, Webber S, Beerman L, Arora G. Natural history of Wolff-Parkinson-White syndrome diagnosed in childhood. *Am J Cardiol* 2013;**112**:961–965.
 473. Brugada J, Puigfel M, Mont L, Garcia-Bolao I, Figueiredo M, Matas M, Navarro-Lopez F. Radiofrequency ablation of anteroseptal, para-Hisian, and mid-septal accessory pathways using a simplified femoral approach. *Pacing Clin Electrophysiol* 1998;**21**:735–741.
 474. Calkins H, Yong P, Miller JM, Olshansky B, Carlson M, Saul JP, Huang SK, Liem LB, Klein LS, Moser SA, Bloch DA, Gillette P, Prystowsky E. Catheter ablation of accessory pathways, atrioventricular nodal reentrant tachycardia, and the atrioventricular junction: final results of a prospective, multicenter clinical trial. The Atakr Multicenter Investigators Group. *Circulation* 1999;**99**:262–270.
 475. Schaffer MS, Silka MJ, Ross BA, Kugler JD. Inadvertent atrioventricular block during radiofrequency catheter ablation. Results of the Pediatric Radiofrequency Ablation Registry. Pediatric Electrophysiology Society. *Circulation* 1996;**94**:3214–3220.
 476. Bravo L, Atenza F, Eidelman G, Ávila P, Pelliza M, Castellanos E, Loughlin G, Datino T, Torrecilla EG, Almendral J, Sánchez PL, Arenal Á, Martínez-Alzamora N, Fernández-Avilés F. Safety and efficacy of cryoablation vs. radiofrequency ablation of septal accessory pathways: systematic review of the literature and meta-analyses. *Europace* 2017;**20**:1334–1342.
 477. Al-Khatib SM, Arshad A, Balk EM, Das SR, Hsu JC, Joglar JA, Page RL. Risk stratification for arrhythmic events in patients with asymptomatic pre-excitation: a systematic review for the 2015 ACC/AHA/HRS guideline for the management of adult patients with supraventricular tachycardia: a report of the American College of Cardiology/American Heart Association Task Force on Clinical Practice Guidelines and the Heart Rhythm Society. *J Am Coll Cardiol* 2016;**67**:1624–1638.
 478. Dai C, Guo B, Li W, Xiao Y, Jin M, Han L, Dong J. The effect of ventricular pre-excitation on ventricular wall motion and left ventricular systolic function. *Europace* 2018;**20**:1175–1181.
 479. Kohli U, Pumphrey KL, Ahmed A, Das S. Pre-excitation induced ventricular dysfunction and successful Berlin heart explantation after accessory pathway ablation. *J Electrocardiol* 2018;**51**:1067–1070.
 480. Nagai T, Hamabe A, Arakawa J, Tabata H, Nishioka T. The impact of left ventricular deformation and dyssynchrony on improvement of left ventricular ejection fraction following radiofrequency catheter ablation in Wolff-Parkinson-White syndrome: a comprehensive study by speckle tracking echocardiography. *Echocardiography* 2017;**34**:1610–1616.
 481. Kwon EN, Carter KA, Kanter RJ. Radiofrequency catheter ablation for dyssynchrony-induced dilated cardiomyopathy in an infant. *Congenit Heart Dis* 2014;**9**:E179–E184.
 482. Telishevska M, Hebe J, Paul T, Nurnberg JH, Krause U, Gebauer R, Gass M, Balmer C, Berger F, Molatta S, Emmel M, Lawrenz W, Kriebel T, Hessler G. Catheter ablation in ASymptomatic PEDiatric patients with ventricular preexcitation: results from the multicenter "CASPED" study. *Clin Res Cardiol* 2018;**108**:683–690.
 483. Marelli AJ, Ionescu-Ittu R, Mackie AS, Guo L, Dendukuri N, Kaouache M. Lifetime prevalence of congenital heart disease in the general population from 2000 to 2010. *Circulation* 2014;**130**:749–756.
 484. Hernandez-Madrid A, Paul T, Abrams D, Aziz PF, Blom NA, Chen J, Chessa M, Combes N, Dagues N, Diller G, Ernst S, Giamberti A, Hebe J, Janousek J, Kriebel T, Moltedo J, Moreno J, Peinado R, Pison L, Rosenthal E, Skinner JR, Zeppenfeld K; ESC Scientific Document Group. Arrhythmias in congenital heart disease: a position paper of the European Heart Rhythm Association (EHRA), Association for European Paediatric and Congenital Cardiology (AEPC), and the European Society of Cardiology (ESC) Working Group on Grown-up Congenital Heart Disease, endorsed by HRS, PACES, APHRS, and SOLAECE. *Europace* 2018;**20**:1719–1753.
 485. Moons P, Bovijn L, Budts W, Belmans A, Gewillig M. Temporal trends in survival to adulthood among patients born with congenital heart disease from 1970 to 1992 in Belgium. *Circulation* 2010;**122**:2264–2272.
 486. Avila P, Mercier LA, Dore A, Marcotte F, Mongeot FP, Ibrahim R, Asgar A, Miro J, Andelfinger G, Mondesert B, de Guise P, Poirier N, Khairy P. Adult congenital heart disease: a growing epidemic. *Can J Cardiol* 2014;**30**:S410–S419.
 487. Janson CM, Shah MJ. Supraventricular tachycardia in adult congenital heart disease: mechanisms, diagnosis, and clinical aspects. *Card Electrophysiol Clin* 2017;**9**:189–211.
 488. Verheugt CL, Uiterwaal CS, van der Velde ET, Meijboom FJ, Pieper PG, Sieswerda GT, Plokker HW, Grobbee DE, Mulder BJ. The emerging burden of hospital admissions of adults with congenital heart disease. *Heart* 2010;**96**:872–878.
 489. Gallego P, Gonzalez AE, Sanchez-Recalde A, Peinado R, Polo L, Gomez-Rubin C, Lopez-Sendon JL, Oliver JM. Incidence and predictors of sudden cardiac arrest in adults with congenital heart defects repaired before adult life. *Am J Cardiol* 2012;**110**:109–117.

490. Koyak Z, Harris L, de Groot JR, Silversides CK, Oechslin EN, Bouma BJ, Budts W, Zwiderman AH, Van Gelder IC, Mulder BJ. Sudden cardiac death in adult congenital heart disease. *Circulation* 2012;**126**:1944–1954.
491. Lin JH, Kean AC, Cordes TM. The risk of thromboembolic complications in Fontan patients with atrial flutter/fibrillation treated with electrical cardioversion. *Pediatr Cardiol* 2016;**37**:1351–1360.
492. Ammash NM, Phillips SD, Hodge DO, Connolly HM, Grogan MA, Friedman PA, Warnes CA, Asirvatham SJ. Outcome of direct current cardioversion for atrial arrhythmias in adults with congenital heart disease. *Int J Cardiol* 2012;**154**:270–274.
493. Israel CV, Barold SS. Electrical storm in patients with an implanted defibrillator: a matter of definition. *Ann Noninvasive Electrocardiol* 2007;**12**:375–382.
494. Sherman L, Niemann J, Youngquist ST, Shah AP, Rosborough JP. Beta-blockade causes a reduction in the frequency spectrum of VF but improves resuscitation outcome: a potential limitation of quantitative waveform measures. *Resuscitation* 2012;**83**:511–516.
495. Khairy P, Clair M, Fernandes SM, Blume ED, Powell AJ, Newburger JW, Landzberg MJ, Mayer JE. Cardiovascular outcomes after the arterial switch operation for D-transposition of the great arteries. *Circulation* 2013;**127**:331–339.
496. Coughtrie AL, Behr ER, Layton D, Marshall V, Camm AJ, Shakir SAW. Drugs and life-threatening ventricular arrhythmia risk: results from the DARE study cohort. *BMJ Open* 2017;**7**:e016627.
497. Valentino MA, Panakos A, Ragupathi L, Williams J, Pavri BB. Flecainide toxicity: a case report and systematic review of its electrocardiographic patterns and management. *Cardiovasc Toxicol* 2017;**17**:260–266.
498. Thorne SA, Barnes I, Cullinan P, Somerville J. Amiodarone-associated thyroid dysfunction. Risk factors in adults with congenital heart disease. *Circulation* 1999;**100**:149–154.
499. Pujol C, Niesert A-C, Engelhardt A, Schoen P, Kusmenkov E, Pittrow D, Ewert P, Kaemmerer H. Usefulness of direct oral anticoagulants in adult congenital heart disease. *Am J Cardiol* 2016;**117**:450–455.
500. Wu J, Deisenhofer I, Ammar S, Fichtner S, Reents T, Zhu P, Jilek C, Kolb C, Hess J, Hessler G. Acute and long-term outcome after catheter ablation of supraventricular tachycardia in patients after the Mustard or Senning operation for D-transposition of the great arteries. *Europace* 2013;**15**:886–891.
501. Roten L, Lukac P, De Groot N, Cosedis Nielsen J, Szili-Torok T, Kjaerulf Jensen H, Zimmermann M, Delacretaz E. Catheter ablation of arrhythmias in Ebstein's anomaly: a multicenter study. *J Cardiovasc Electrophysiol* 2011;**22**:1391–1396.
502. Deal BJ, Mavroudis C. Arrhythmia surgery for adults with congenital heart disease. *Card Electrophysiol Clin* 2017;**9**:329–340.
503. Shivapur JK, Sherwin ED, Alexander ME, Cecchin F, Mah DY, Triedman JK, Marx GR, del Nido PJ, Walsh EP. Utility of preoperative electrophysiologic studies in patients with Ebstein's anomaly undergoing the Cone procedure. *Heart Rhythm* 2014;**11**:182–186.
504. Deal BJ, Mavroudis C, Backer CL, Buck SH, Johnsrude C. Comparison of anatomic isthmus block with the modified right atrial maze procedure for late atrial tachycardia in Fontan patients. *Circulation* 2002;**106**:575–579.
505. Koyak Z, Kroon B, de Groot JR, Wagenaar LJ, van Dijk AP, Mulder BA, Van Gelder IC, Post MC, Mulder BJM, Bouma BJ. Efficacy of antiarrhythmic drugs in adults with congenital heart disease and supraventricular tachycardias. *Am J Cardiol* 2013;**112**:1461–1467.
506. Combes N, Derval N, Hascoet S, Zhao A, Amat D, Le Bloa M, Maltret A, Heitz F, Thambo JB, Marjion E. Ablation of supraventricular arrhythmias in adult congenital heart disease: a contemporary review. *Arch Cardiovasc Dis* 2017;**110**:334–345.
507. Dallaglio PD, Anguera I, Jiménez-Candil J, Peinado R, García-Seara J, Arcocha MF, Macías R, Herreros B, Quesada A, Hernández-Madrid A, Alvarez M, Di Marco A, Filgueiras D, Matía R, Cequeira A, Sabaté X. Impact of previous cardiac surgery on long-term outcome of cavotricuspid isthmus-dependent atrial flutter ablation. *Europace* 2016;**18**:873–880.
508. Wasmer K, Köbe J, Decherung DG, Bittner A, Mönning G, Milberg P, Baumgartner H, Breithardt G, Eckardt L. Isthmus-dependent right atrial flutter as the leading cause of atrial tachycardias after surgical atrial septal defect repair. *Int J Cardiol* 2013;**168**:2447–2452.
509. Nie J-G, Dong J-Z, Salim M, Li S-N, Wu X-Y, Chen Y-W, Bai R, Liu N, Du X, Ma C-S. Catheter ablation of atrial fibrillation in patients with atrial septal defect: long-term follow-up results. *J Interv Card Electrophysiol* 2015;**42**:43–49.
510. Chauvaud SM, Brancaccio G, Carpentier AF. Cardiac arrhythmia in patients undergoing surgical repair of Ebstein's anomaly. *Ann Thorac Surg* 2001;**71**:1547–1552.
511. Khairy P, Van Hare GF, Balaji S, Berul CI, Cecchin F, Cohen MI, Daniels CJ, Deal BJ, Dearani JA, Groot Nd, Dubin AM, Harris L, Janousek J, Kanter RJ, Karpawich PP, Perry JC, Sestor SP, Shah MJ, Silka MJ, Triedman JK, Walsh EP, Warnes CA. PACES/HRS Expert Consensus Statement on the Recognition and Management of Arrhythmias in Adult Congenital Heart Disease: Developed in partnership between the Pediatric and Congenital Electrophysiology Society (PACES) and the Heart Rhythm Society (HRS). Endorsed by the governing bodies of PACES, HRS, the American College of Cardiology (ACC), the American Heart Association (AHA), the European Heart Rhythm Association (EHRA), the Canadian Heart Rhythm Society (CHRS), and the International Society for Adult Congenital Heart Disease (ISACHD). *Heart Rhythm* 2014;**11**:e102–e165.
512. Khositseth A, Danielson GK, Dearani JA, Munger TM, Porter CJ. Supraventricular tachyarrhythmias in Ebstein anomaly: management and outcome. *J Thorac Cardiovasc Surg* 2004;**128**:826–833.
513. Shivapur JK, Sherwin ED, Alexander ME, Cecchin F, Mah DY, Triedman JK, Marx GR, del Nido PJ, Walsh EP. Utility of preoperative electrophysiologic studies in patients with Ebstein's anomaly undergoing the Cone procedure. *Heart Rhythm* 2014;**11**:182–186.
514. Correa R, Walsh EP, Alexander ME, Mah DY, Cecchin F, Abrams DJ, Triedman JK. Transbaffle mapping and ablation for atrial tachycardias after mustard, senning, or Fontan operations. *J Am Heart Assoc* 2013;**2**:e000325.
515. Krause U, Backhoff D, Klehs S, Schneider HE, Paul T. Transbaffle catheter ablation of atrial re-entrant tachycardia within the pulmonary venous atrium in adult patients with congenital heart disease. *Europace* 2016;**18**:1055–1060.
516. Houck CA, Teuwen CP, Bogers AJ, de Groot NM. Atrial tachyarrhythmias after atrial switch operation for transposition of the great arteries: treating old surgery with new catheters. *Heart Rhythm* 2016;**13**:1731–1738.
517. Wu M-H, Lu C-W, Chen H-C, Chiu S-N, Kao F-Y, Huang S-K. Arrhythmic burdens in patients with tetralogy of Fallot: a national database study. *Heart Rhythm* 2015;**12**:604–609.
518. de Groot NMS, Lukac P, Schalij MJ, Makowski K, Szili-Torok T, Jordaens L, Nielsen JC, Nens HK, Gerdes JC, Delacretaz E. Long-term outcome of ablative therapy of post-operative atrial tachyarrhythmias in patients with tetralogy of Fallot: a European multi-centre study. *Europace* 2012;**14**:522–527.
519. Weipert J, Noebauer C, Schreiber C, Kostolny M, Zrenner B, Wacker A, Hess J, Lange R. Occurrence and management of atrial arrhythmia after long-term Fontan circulation. *J Thorac Cardiovasc Surg* 2004;**127**:457–464.
520. Mavroudis C, Deal BJ. Fontan conversion: literature review and lessons learned over 20 years. *World J Pediatr Congenit Heart Surg* 2016;**7**:192–198.
521. Stewart RD, Pasquali SK, Jacobs JP, Benjamin DK, Jagers J, Cheng J, Mavroudis C, Jacobs ML. Contemporary Fontan operation: association between early outcome and type of cavopulmonary connection. *Ann Thorac Surg* 2012;**93**:1254–1260; discussion 1261.
522. Brugada J, Blom N, Sarquella-Brugada G, Blomstrom-Lundqvist C, Deanfield J, Janousek J, Abrams D, Bauersfeld U, Brugada R, Drago F, de Groot N, Happonen J-M, Hebe J, Yen Ho S, Marjion E, Paul T, Pfammatter J-P, Rosenthal E. Pharmacological and non-pharmacological therapy for arrhythmias in the pediatric population: EHRA and AEPCC-Arrhythmia Working Group joint consensus statement. *Europace* 2013;**15**:1337–1382.
523. Philip Saul J, Kanter RJ, Writing C, Abrams D, Asirvatham S, Bar-Cohen Y, Blaufox AD, Cannon B, Clark J, Dick M, Freter A, Kertesz NJ, Kirsh JA, Kugler J, LaPage M, McGowan FX, Miyake CY, Nathan A, Papagiannis J, Paul T, Pflaumer A, Skanes AC, Stevenson WG, Von Bergen N, Zimmerman F. PACES/HRS expert consensus statement on the use of catheter ablation in children and patients with congenital heart disease: developed in partnership with the Pediatric and Congenital Electrophysiology Society (PACES) and the Heart Rhythm Society (HRS). Endorsed by the governing bodies of PACES, HRS, the American Academy of Pediatrics (AAP), the American Heart Association (AHA), and the Association for European Pediatric and Congenital Cardiology (AEPCC). *Heart Rhythm* 2016;**13**:e251–e289.
524. Perry JC, Garson A Jr. Supraventricular tachycardia due to Wolff-Parkinson-White syndrome in children: early disappearance and late recurrence. *J Am Coll Cardiol* 1990;**16**:1215–1220.
525. Bensler JM, Frank CM, Razavi M, Rasekh A, Saeed M, Haas PC, Nazeri A, Massumi A. Tachycardia-mediated cardiomyopathy and the permanent form of junctional reciprocating tachycardia. *Tex Heart Inst J* 2010;**37**:695–698.
526. Ellis ER, Josephson ME. What about tachycardia-induced cardiomyopathy? *Arrhythm Electrophysiol Rev* 2013;**2**:82–90.
527. Richardson C, Silver ES. Management of supraventricular tachycardia in infants. *Paediatr Drugs* 2017;**19**:539–551.
528. Lewis J, Arora G, Tudorascu DL, Hickey RW, Saladino RA, Manole MD. Acute management of refractory and unstable pediatric supraventricular tachycardia. *J Pediatr* 2017;**181**:177–182.e2.
529. Saul JP, Hulse JE, Papagiannis J, Van Praagh R, Walsh EP. Late enlargement of radiofrequency lesions in infant lambs. Implications for ablation procedures in small children. *Circulation* 1994;**90**:492–499.
530. Femenía F, Sarquella-Brugada G, Brugada J. Single-catheter radiofrequency ablation of a permanent junctional reciprocating tachycardia in a premature neonate. *Cardiol Young* 2012;**22**:606–609.
531. Hinkle KA, Peyvandi S, Stiver C, Killen SAS, Weng HY, Etheridge SP, Puchalski MD. Postnatal outcomes of fetal supraventricular tachycardia: a multicenter study. *Pediatr Cardiol* 2017;**38**:1317–1323.

532. Fouron J-C, Fournier A, Proulx F, Lamarche J, Bigras JL, Boutin C, Brassard M, Gamache S. Management of fetal tachyarrhythmia based on superior vena cava/aorta Doppler flow recordings. *Heart* 2003;**89**:1211–1216.
533. Jaeggi ET, Carvalho JS, De Groot E, Api O, Clur S-AB, Rammeloo L, McCrindle BW, Ryan G, Manliot C, Blom NA. Comparison of transplacental treatment of fetal supraventricular tachyarrhythmias with digoxin, flecainide, and sotalol: results of a nonrandomized multicenter study. *Circulation* 2011;**124**:1747–1754.
534. Price JF, Kertesz NJ, Snyder CS, Friedman RA, Fenrich AL. Flecainide and sotalol: a new combination therapy for refractory supraventricular tachycardia in children <1 year of age. *J Am Coll Cardiol* 2002;**39**:517–20.
535. Vaidya VR, Arora S, Patel N, Badheka AO, Patel N, Agnihotri K, Billimoria Z, Turakha MP, Friedman PA, Madhavan M, Kapa S, Noseworthy PA, Cha Y-M, Gersh B, Asirvatham SJ, Deshmukh AJ. Burden of arrhythmia in pregnancy. *Circulation* 2017;**135**:619–621.
536. Opatowsky AR, Siddiqi OK, D'Souza B, Webb GD, Fernandes SM, Landzberg MJ. Maternal cardiovascular events during childbirth among women with congenital heart disease. *Heart* 2012;**98**:145–151.
537. Silversides CK, Harris L, Haberer K, Sermer M, Colman JM, Siu SC. Recurrence rates of arrhythmias during pregnancy in women with previous tachyarrhythmia and impact on fetal and neonatal outcomes. *Am J Cardiol* 2006;**97**:1206–1212.
538. Lee SH, Chen SA, Wu TJ, Chiang CE, Cheng CC, Tai CT, Chiou CW, Ueng KC, Chang MS. Effects of pregnancy on first onset and symptoms of paroxysmal supraventricular tachycardia. *Am J Cardiol* 1995;**76**:675–678.
539. Moore JS, Teefey P, Rao K, Berlowitz MS, Chae SH, Yankowitz J. Maternal arrhythmia: a case report and review of the literature. *Obstet Gynecol Surv* 2012;**67**:298–312.
540. Wang YC, Chen CH, Su HY, Yu MH. The impact of maternal cardioversion on fetal haemodynamics. *Eur J Obstet Gynecol Reprod Biol* 2006;**126**:268–269.
541. Elkayam U, Goodwin TM. Adenosine therapy for supraventricular tachycardia during pregnancy. *Am J Cardiol* 1995;**75**:521–523.
542. Ghosh N, Luk A, Derzko C, Dorian P, Chow CM. The acute treatment of maternal supraventricular tachycardias during pregnancy: a review of the literature. *J Obstet Gynaecol Can* 2011;**33**:17–23.
543. Halpern DG, Weinberg CR, Pinnelas R, Mehta-Lee S, Economy KE, Valente AM. Use of medication for cardiovascular disease during pregnancy: JACC State-of-the-Art Review. *J Am Coll Cardiol* 2019;**73**:457–476.
544. Kockova R, Kocka V, Kiernan T, Fahy GJ. Ibutilide-induced cardioversion of atrial fibrillation during pregnancy. *J Cardiovasc Electrophysiol* 2007;**18**:545–547.
545. Burkart TA, Kron J, Miles WM, Conti JB, Gonzalez MD. Successful termination of atrial flutter by ibutilide during pregnancy. *Pacing Clin Electrophysiol* 2007;**30**:283–286.
546. Liu YL, Nwosu UC, Rice PJ. Relaxation of isolated human myometrial muscle by beta2-adrenergic receptors but not beta1-adrenergic receptors. *Am J Obstet Gynecol* 1998;**179**:895–898.
547. Tanaka K, Tanaka H, Kamiya C, Katsuragi S, Sawada M, Tsuritani M, Yoshida M, Iwanaga N, Yoshimatsu J, Ikeda T. Beta-blockers and fetal growth restriction in pregnant women with cardiovascular disease. *Circ J* 2016;**80**:2221–2226.
548. Bateman BT, Heide-Jorgensen U, Einarsdottir K, Engeland A, Furu K, Gissler M, Hernandez-Diaz S, Kieler H, Lahesmaa-Korpinen AM, Mogun H, Norgaard M, Reutfors J, Selmer R, Huybrechts KF, Zoega H. Beta-blocker use in pregnancy and the risk for congenital malformations: an international cohort study. *Ann Intern Med* 2018;**169**:665–673.
549. Jaeggi ET, Carvalho JS, De Groot E, Api O, Clur SA, Rammeloo L, McCrindle BW, Ryan G, Manliot C, Blom NA. Comparison of transplacental treatment of fetal supraventricular tachyarrhythmias with digoxin, flecainide, and sotalol: results of a nonrandomized multicenter study. *Circulation* 2011;**124**:1747–1754.
550. Driver K, Chisholm CA, Darby AE, Malhotra R, Dimarco JP, Ferguson JD. Catheter ablation of arrhythmia during pregnancy. *J Cardiovasc Electrophysiol* 2015;**26**:698–702.
551. Chen G, Sun G, Xu R, Chen X, Yang L, Bai Y, Yang S, Guo P, Zhang Y, Zhao C, Wang DW, Wang Y. Zero-fluoroscopy catheter ablation of severe drug-resistant arrhythmia guided by Ensite NavX system during pregnancy: two case reports and literature review. *Medicine (Baltimore)* 2016;**95**:e4487.
552. Szumowski L, Szafladowicz E, Orczykowski M, Bodalski R, Derejko P, Przybylski A, Urbanek P, Kusmierczyk M, Kozluk E, Sacher F, Sanders P, Dangel J, Haissaguerre M, Walczak F. Ablation of severe drug-resistant tachyarrhythmia during pregnancy. *J Cardiovasc Electrophysiol* 2010;**21**:877–882.
553. Duan L, Ng A, Chen W, Spencer HT, Nguyen J, Shen AY, Lee MS. Beta-blocker exposure in pregnancy and risk of fetal cardiac anomalies. *JAMA Intern Med* 2017;**177**:885–887.
554. Duan L, Ng A, Chen W, Spencer HT, Lee MS. Beta-blocker subtypes and risk of low birth weight in newborns. *J Clin Hypertens (Greenwich)* 2018;**20**:1603–1609.
555. Bergman JEH, Lutke LR, Gans ROB, Addor MC, Barisic I, Caverro-Carbonell C, Garne E, Gatt M, Klungsoyr K, Lelong N, Lynch C, Mokoroa O, Nelen V, Neville AJ, Pierini A, Randrianaivo H, Rissmann A, Tucker D, Wiesel A, Dolk H, Loane M, Bakker MK. Beta-blocker use in pregnancy and risk of specific congenital anomalies: a European case-malformed control study. *Drug Saf* 2018;**41**:415–427.
556. Razminia M, Willoughby MC, Demo H, Keshmiri H, Wang T, D'Silva OJ, Zheutlin TA, Jibawi H, Okhumale P, Kehoe RF. Fluorless catheter ablation of cardiac arrhythmias: a 5-year experience. *Pacing Clin Electrophysiol* 2017;**40**:425–433.
557. Lishmanov A, Chockalingam P, Senthilkumar A, Chockalingam A. Tachycardia-induced cardiomyopathy: evaluation and therapeutic options. *Congest Heart Fail* 2010;**16**:122–126.
558. Nerheim P, Birger-Botkin S, Piracha L, Olshansky B. Heart failure and sudden death in patients with tachycardia-induced cardiomyopathy and recurrent tachycardia. *Circulation* 2004;**110**:247–252.
559. Shinbane JS, Wood MA, Jensen DN, Ellenbogen KA, Fitzpatrick AP, Scheinman MM. Tachycardia-induced cardiomyopathy: a review of animal models and clinical studies. *J Am Coll Cardiol* 1997;**29**:709–715.
560. Ellis ER, Josephson ME. Heart failure and tachycardia-induced cardiomyopathy. *Curr Heart Fail Rep* 2013;**10**:296–306.
561. Gopinathannair R, Etheridge SP, Marchlinski FE, Spinale FG, Lakkireddy D, Olshansky B. Arrhythmia-induced cardiomyopathies: mechanisms, recognition, and management. *J Am Coll Cardiol* 2015;**66**:1714–1728.
562. Callans DJ. Premature ventricular contraction-induced cardiomyopathy. *Arrhythm Electrophysiol Rev* 2017;**6**:153–155.
563. Clementy N, Casset-Senon D, Giraudeau C, Cosnay P. Tachycardiomyopathy secondary to nonreentrant atrioventricular nodal tachycardia: recovery after slow pathway ablation. *Pacing Clin Electrophysiol* 2007;**30**:925–928.
564. Gopinathannair R, Sullivan RM, Olshansky B. Tachycardia-mediated cardiomyopathy: recognition and management. *Curr Heart Fail Rep* 2009;**6**:257–264.
565. Mueller KAL, Heinzmann D, Klingel K, Fallier-Becker P, Kandolf R, Kilias A, Walker-Allgaier B, Borst O, Kumbrink J, Kirchner T, Langer H, Geisler T, Schreck J, Gramlich M, Gawaz M, Seizer P. Histopathological and immunological characteristics of tachycardia-induced cardiomyopathy. *J Am Coll Cardiol* 2017;**69**:2160–2172.
566. Cha Y-M, Lee GK, Klarich KW, Grogan M. Premature ventricular contraction-induced cardiomyopathy. A treatable condition. *Circ Arrhythm Electrophysiol* 2012;**5**:229–236.
567. Kotecha D, Flather MD, Altman DG, Holmes J, Rosano G, Wikstrand J, Packer M, Coats AJS, Manzano L, Böhm M, van Veldhuisen DJ, Andersson B, Wedel H, von Lueder TG, Rigby AS, Hjalmarson Å, Kjekshus J, Cleland JGF. Heart rate and rhythm and the benefit of beta-blockers in patients with heart failure. *J Am Coll Cardiol* 2017;**69**:2885–2896.
568. Sadron Blaye-Felice M, Hamon D, Sacher F, Pascale P, Rollin A, Duparc A, Mondoly P, Derval N, Denis A, Cardin C, Hocini M, Jaïs P, Schlaepfer J, Bongard V, Carrié D, Galinier M, Pruvot E, Lellouche N, Haïssaguerre M, Maury P. Premature ventricular contraction-induced cardiomyopathy: related clinical and electrophysiologic parameters. *Heart Rhythm* 2016;**13**:103–110.
569. Sohinki D, Ho J, Srinivasan N, Collins LJ, Obel OA. Outcomes after atrioventricular node ablation and biventricular pacing in patients with refractory atrial fibrillation and heart failure: a comparison between non-ischaemic and ischaemic cardiomyopathy. *Europace* 2014;**16**:880–886.
570. Stavrakis S, Garabelli P, Reynolds DW. Cardiac resynchronization therapy after atrioventricular junction ablation for symptomatic atrial fibrillation: a meta-analysis. *Europace* 2012;**14**:1490–1497.
571. Brignole M, Botto G, Mont L, Iacopino S, De Marchi G, Oddone D, Luzi M, Tolosana JM, Navazio A, Menozzi C. Cardiac resynchronization therapy in patients undergoing atrioventricular junction ablation for permanent atrial fibrillation: a randomized trial. *Eur Heart J* 2011;**32**:2420–2429.
572. Huang W, Su L, Wu S, Xu L, Xiao F, Zhou X, Ellenbogen KA. Benefits of permanent His bundle pacing combined with atrioventricular node ablation in atrial fibrillation patients with heart failure with both preserved and reduced left ventricular ejection fraction. *J Am Heart Assoc* 2017;**6**:e005309.
573. Pelliccia A, Fagard R, Bjørnstad HH, Anastassakis A, Arbustini E, Assanelli D, Biffi A, Borjesson M, Carré F, Corrado D, Delise P, Dorwarth U, Hirth A, Heidbuchel H, Hoffmann E, Mellwig KP, Panhuyzen-Goedkoop N, Pisani A, Solberg EE, van Buuren F, Vanhees L, Blomstrom-Lundqvist C, Deligiannis A, Dugmore D, Glikson M, Hoff PI, Hoffmann A, Hoffmann E, Horstkotte D, Nordrehaug JE, Oudhof J, McKenna WJ, Penco M, Priori S, Reybrouck T, Senden J, Spataro A, Thiene G; Study Group of Sports Cardiology of the Working Group of Cardiac Rehabilitation and Exercise Physiology; Working Group of Myocardial and Pericardial Diseases of the European Society of Cardiology. Recommendations for competitive sports participation in athletes with cardiovascular disease: a consensus document from the Study Group of Sports Cardiology of the Working Group of Cardiac Rehabilitation and Exercise Physiology and the Working Group of Myocardial and Pericardial Diseases of the European Society of Cardiology. *Eur Heart J* 2005;**26**:1422–1445.

574. Heidbüchel H, Panhuyzen-Goedkoop N, Corrado D, Hoffmann E, Biffi A, Delise P, Blomstrom-Lundqvist C, Vanhees L, Hoff PI, Dorwarth U, Pelliccia A; Study Group on Sports Cardiology of the European Association for Cardiovascular Prevention and Rehabilitation. Recommendations for participation in leisure-time physical activity and competitive sports in patients with arrhythmias and potentially arrhythmogenic conditions Part I: supraventricular arrhythmias and pacemakers. *Eur J Cardiovasc Prev Rehabil* 2006;**13**:475–484.
575. Rao AL, Salerno JC, Asif IM, Drezner JA. Evaluation and management of Wolff-Parkinson-White in athletes. *Sports health: a multidisciplinary approach* 2014;**6**:326–332.
576. Abdulla J, Nielsen JR. Is the risk of atrial fibrillation higher in athletes than in the general population? A systematic review and meta-analysis. *Europace* 2009;**11**:1156–1159.
577. Heidbüchel H, Panhuyzen-Goedkoop N, Corrado D, Hoffmann E, Biffi A, Delise P, Blomstrom-Lundqvist C, Vanhees L, Ivarhoff P, Dorwarth U, Pelliccia A; Study Group on Sports Cardiology of the European Association for Cardiovascular Prevention and Rehabilitation. Recommendations for participation in leisure-time physical activity and competitive sports in patients with arrhythmias and potentially arrhythmogenic conditions Part I: supraventricular arrhythmias and pacemakers. *Eur J Cardiovasc Prev Rehabil* 2006;**13**:475–484.
578. Heidbüchel H, Corrado D, Biffi A, Hoffmann E, Panhuyzen-Goedkoop N, Hoogsteen J, Delise P, Hoff PI, Pelliccia A; Study Group on Sports Cardiology of the European Association for Cardiovascular Prevention and Rehabilitation. Recommendations for participation in leisure-time physical activity and competitive sports of patients with arrhythmias and potentially arrhythmogenic conditions. Part II: ventricular arrhythmias, channelopathies and implantable defibrillators. *Eur J Cardiovasc Prev Rehabil* 2006;**13**:676–686.
579. Katritsis D, Anderson A, Webb-Peploe MM. Regulations concerning individual risk and public safety. ESC Textbook of Cardiology 2018.
580. European Working Group on Driving and Cardiovascular Disease. New standards for driving and cardiovascular diseases. Report of the Expert Group on Driving and Cardiovascular Disease. https://ec.europa.eu/transport/road_safety/sites/roadsafety/files/pdf/behavior/driving_and_cardiovascular_disease_final.pdf (date accessed May 2019).
581. Nakagawa H, Natale A. Catheter ablation of complex tachyarrhythmias using remote magnetic catheter navigation system. *J Cardiovasc Electrophysiol* 2016;**27**:S3–S4.
582. Hilbert S, Sommer P, Gutberlet M, Gaspar T, Foldyna B, Piorowski C, Weiss S, Lloyd T, Schnackenburg B, Krueger S, Fleiter C, Paetsch I, Jahnke C, Hindricks G, Grothoff M. Real-time magnetic resonance-guided ablation of typical right atrial flutter using a combination of active catheter tracking and passive catheter visualization in man: initial results from a consecutive patient series. *Europace* 2016;**18**:572–577.
583. Perlman O, Katz A, Amit G, Zigel Y. Supraventricular tachycardia classification in the 12-lead ECG using atrial waves detection and a clinically based tree scheme. *IEEE J Biomed Health Inform* 2016;**20**:1513–1520.
584. Katritsis G, Luther V, Kanagaratnam P, Linton NW. Arrhythmia mechanisms revealed by ripple mapping. *Arrhythm Electrophysiol Rev* 2018;**7**:261–264.
585. Luther V, Cortez-Dias N, Carpinteiro L, de Sousa J, Balasubramaniam R, Agarwal S, Farwell D, Sopher M, Babu G, Till R, Jones N, Tan S, Chow A, Lowe M, Lane J, Pappachan N, Linton N, Kanagaratnam P. Ripple mapping: initial multicenter experience of an intuitive approach to overcoming the limitations of 3D activation mapping. *J Cardiovasc Electrophysiol* 2017;**28**:1285–1294.
586. Latcu DG, Bun SS, Viera F, Delassi T, El Jamili M, Al Amoura A, Saoudi N. Selection of critical isthmus in scar-related atrial tachycardia using a new automated ultrahigh resolution mapping system. *Circ Arrhythm Electrophysiol* 2017;**10**:e004510.
587. Walsh KA, Galvin J, Keane J, Keelan E, Szeplaki G. First experience with zero-fluoroscopic ablation for supraventricular tachycardias using a novel impedance and magnetic-field-based mapping system. *Clin Res Cardiol* 2018;**107**:578–585.
588. Luther V, Linton NW, Koa-Wing M, Lim PB, Jamil-Copley S, Qureshi N, Ng FS, Hayat S, Whinnett Z, Davies DW, Peters NS, Kanagaratnam P. A prospective study of ripple mapping in atrial tachycardias: a novel approach to interpreting activation in low-voltage areas. *Circ Arrhythm Electrophysiol* 2016;**9**:e003582.
589. Anter E, McElderry TH, Contreras-Valdes FM, Li J, Tung P, Leshem E, Haffajee CI, Nakagawa H, Josephson ME. Evaluation of a novel high-resolution mapping technology for ablation of recurrent scar-related atrial tachycardias. *Heart Rhythm* 2016;**13**:2048–2055.
590. Gollob MH, Green MS, Tang AS-L, Gollob T, Karibe A, Hassan A-S, Ahmad F, Lozado R, Shah G, Fananapazir L, Bachinski LL, Tapscott T, Gonzales O, Begley D, Mohiddin S, Roberts R. Identification of a gene responsible for familial Wolff-Parkinson-White syndrome. *N Engl J Med* 2001;**344**:1823–1831.
591. Wolf CM, Arad M, Ahmad F, Sanbe A, Bernstein SA, Toka O, Konno T, Morley G, Robbins J, Seidman JG, Seidman CE, Berul CI. Reversibility of PRKAG2 glycogen-storage cardiomyopathy and electrophysiological manifestations. *Circulation* 2008;**117**:144–154.
592. Tan HL, van der Wal AC, Campian ME, Kruijswijk HH, ten Hove Jansen B, van Doorn D-J, Oskam HJ, Becker AE, Wilde AAM. Nodoventricular accessory pathways in PRKAG2-dependent familial preexcitation syndrome reveal a disorder in cardiac development. *Circ Arrhythm Electrophysiol* 2008;**1**:276–281.
593. Lalani SR, Thakuria JV, Cox GF, Wang X, Bi W, Bray MS, Shaw C, Cheung SW, Chinault AC, Boggs BA, Ou Z, Brundage EK, Lupski JR, Gentile J, Waisbren S, Pursley A, Ma L, Khajavi M, Zapata G, Friedman R, Kim JJ, Towbin JA, Stankiewicz P, Schnittger S, Hansmann I, Ai T, Sood S, Wehrens XH, Martin JF, Belmont JW, Potocki L. 20p12.3 microdeletion predisposes to Wolff-Parkinson-White syndrome with variable neurocognitive deficits. *J Med Genet* 2009;**46**:168–175.
594. Sidhu JS, Rajawat YS, Rami TG, Gollob MH, Wang Z, Yuan R, Marian AJ, DeMayo FJ, Weibacher D, Taffet GE, Davies JK, Carling D, Khoury DS, Roberts R. Transgenic mouse model of ventricular preexcitation and atrioventricular reentrant tachycardia induced by an AMP-activated protein kinase loss-of-function mutation responsible for Wolff-Parkinson-White syndrome. *Circulation* 2005;**111**:21–29.
595. Hasdemir C, Payzin S, Kocabas U, Sahin H, Yildirim N, Alp A, Aydin M, Pfeiffer R, Burashnikov E, Wu Y, Antzelevitch C. High prevalence of concealed Brugada syndrome in patients with atrioventricular nodal reentrant tachycardia. *Heart Rhythm* 2015;**12**:1584–1594.
596. Weyhrauch DL, Ye D, Boczek NJ, Tester DJ, Gavrilova RH, Patterson MC, Wieben ED, Ackerman MJ. Whole exome sequencing and heterologous cellular electrophysiology studies elucidate a novel loss-of-function mutation in the CACNA1A-encoded neuronal P/Q-type calcium channel in a child with congenital hypotonia and developmental delay. *Pediatr Neurol* 2016;**55**:46–51.
597. Baruscotti M, Bianco E, Bucchi A, DiFrancesco D. Current understanding of the pathophysiological mechanisms responsible for inappropriate sinus tachycardia: role of the If “funny” current. *J Interv Card Electrophysiol* 2016;**46**:19–28.
598. Josephson ME. Electrophysiology at a crossroads. *Heart Rhythm* 2007;**4**:658–661.